



Bashkia Shkodër

MIRATOHET
KRYETARI I BASHKISË
Znj. VOLTANA ADEMI

PROJEKT ZBATIMI

SISTEMIM - ASFALTIM I RRUGËS OBLIKE - PALLATE

PROJEKTOI:
"LENI-ING" SH.P.K

TIRANË 2021

HOOROGRAFIA E RRUGES



AKSI 3

AKSI 2

AKSI 1

AKSI 3

AKSI 2

AKSI 1

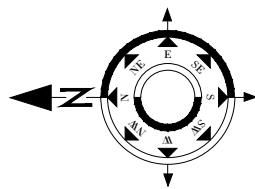

Porositi:



Bashkia Shkoder

Projektoi:

"LENI-ING" sh.p.k

Administrator Ing.Nikoll Paluca

Adresa: Tirane

Mobile: 068 20 42 270

Email: leni.ing@hotmail.com

Objekti: Sistemit - Asfaltim i rrugës Oblike Pallate

Faza:

Projekt - Zbatimi

Emërtimi i Fletës:

HOOROGRAFIA

Shkalla:

Sh - 1:500

Tiranë 2021

HO - 01

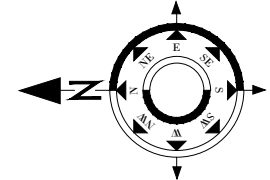

| | | | | | |
|--|----------------|--|------------------------|--|---------|
| | KUOTE | | IZOIPSE | | RRETHIM |
| | RRUGE NATYRALE | | RRUGE ASFALT EKZISTUES | | PORTE |
| | NDERTESA | | | | |

Porositi:



Bashkia Shkoder

Projektoi:

"LENI-ING" sh.p.k

Administrator Ing. Nikoll Paluca

Adresa: Tirane
 Mobile: 068 20 42 270
 Email: leni.ing@hotmail.com

| | | |
|--|--------------------------|-------------|
| Objekti: Sistemim - Asfaltim i rrugës Oblike - Pallate | | |
| Faza: | Projekt - Zbatimi | |
| Emërtimi i Fletës: | Shkalla: | Tiranë 2021 |
| TOPOGRAFIA E RRUGES | Sh-1:500 | T-01 |

PLANIMETRIA E RRUGES

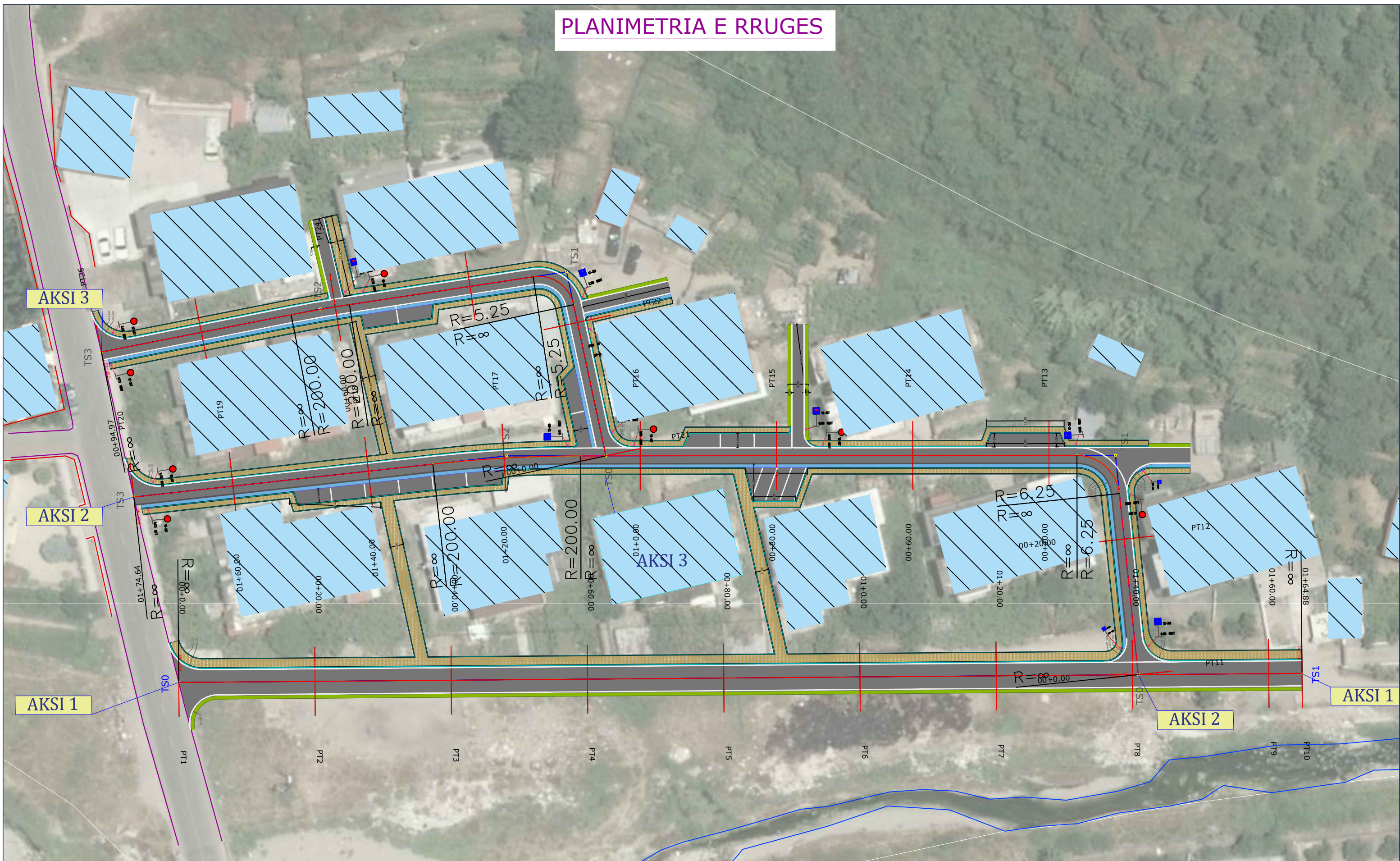

Porositi:



Bashkia Shkoder

Projektoi:
"LENI-ING" sh.p.k
 Administrator Ing.Nikoll Paluca
 Adresa: Tirane
 Mobile: 068 20 42 270
 Email: leni.ing@hotmail.com

| | | |
|--|--------------------------|-------------|
| Objekti: Sistemim - Asfaltim i rrugës Oblike - Pallate | | |
| Faza: | Projekt - Zbatimi | |
| Emërtimi i Fletës: | Shkalla: | Tiranë 2021 |
| PLANIMETRIA E RRUGES | Sh-1:500 | PL-01 |

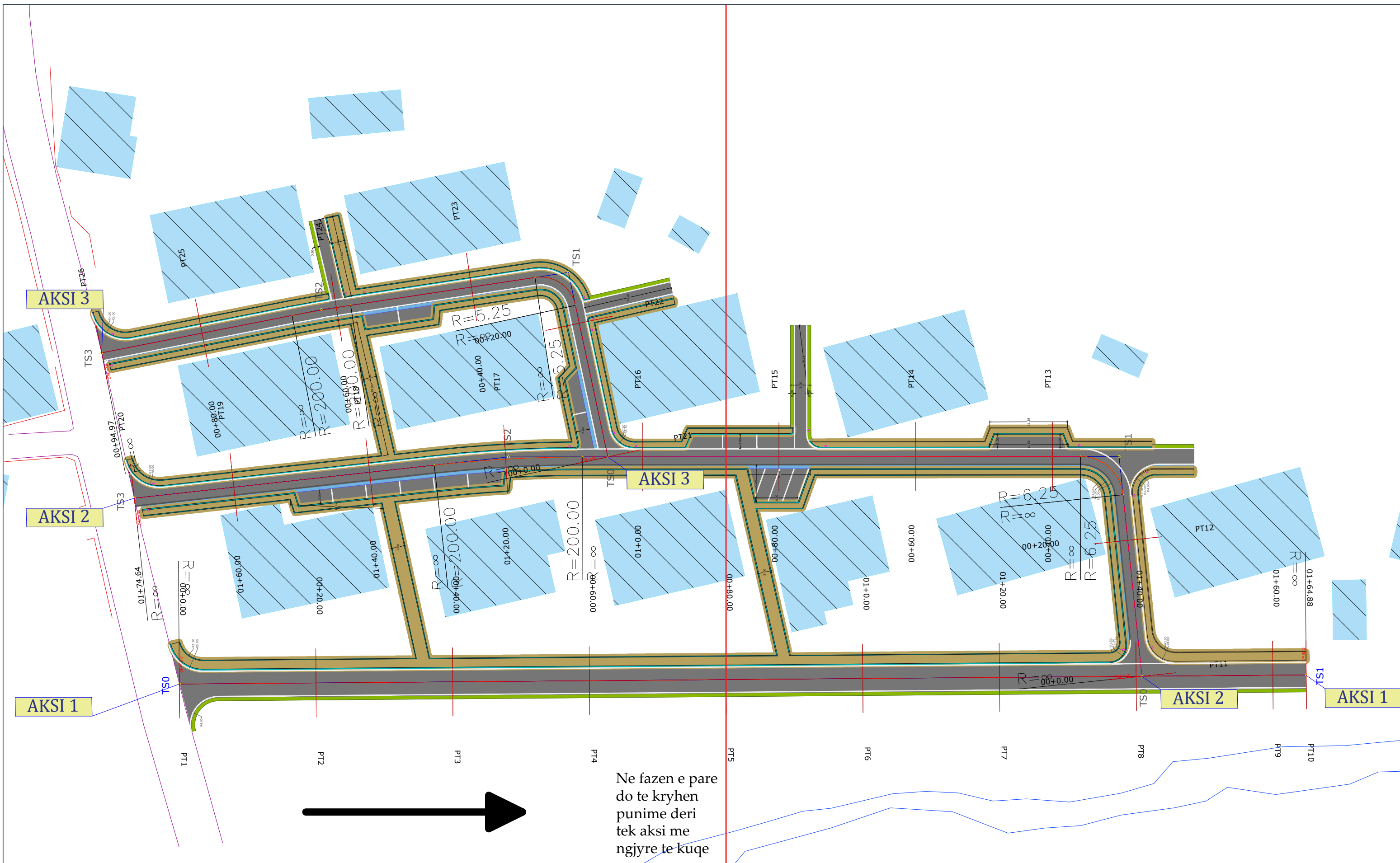

Ne fazen e pare do te kryhen punime deri tek aksi me ngjyre te kuqe

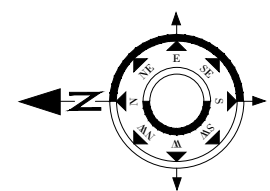

| | | | | | |
|---|--|--|-------------|--|--|
| Porositi:  Bashkia Shkoder | | Projektoi: "LENI-ING" sh.p.k Administrator Ing.Nikoll Paluca Adresa: Tirane Mobile: 068 20 42 270 Email: leni.ing@hotmail.com | | Objekti: Sistemim - Asfaltim i rrugës Oblike - Pallate | |
| | | Faza: Projekt - Zbatimi | | | |
| Emërtimi i Fletës: TOPOGRAFIA E RRUGES | | Shkalla: Sh-1:500 | Tiranë 2021 | T-01 | |

PROFILI GJATESORE

AKSI 1

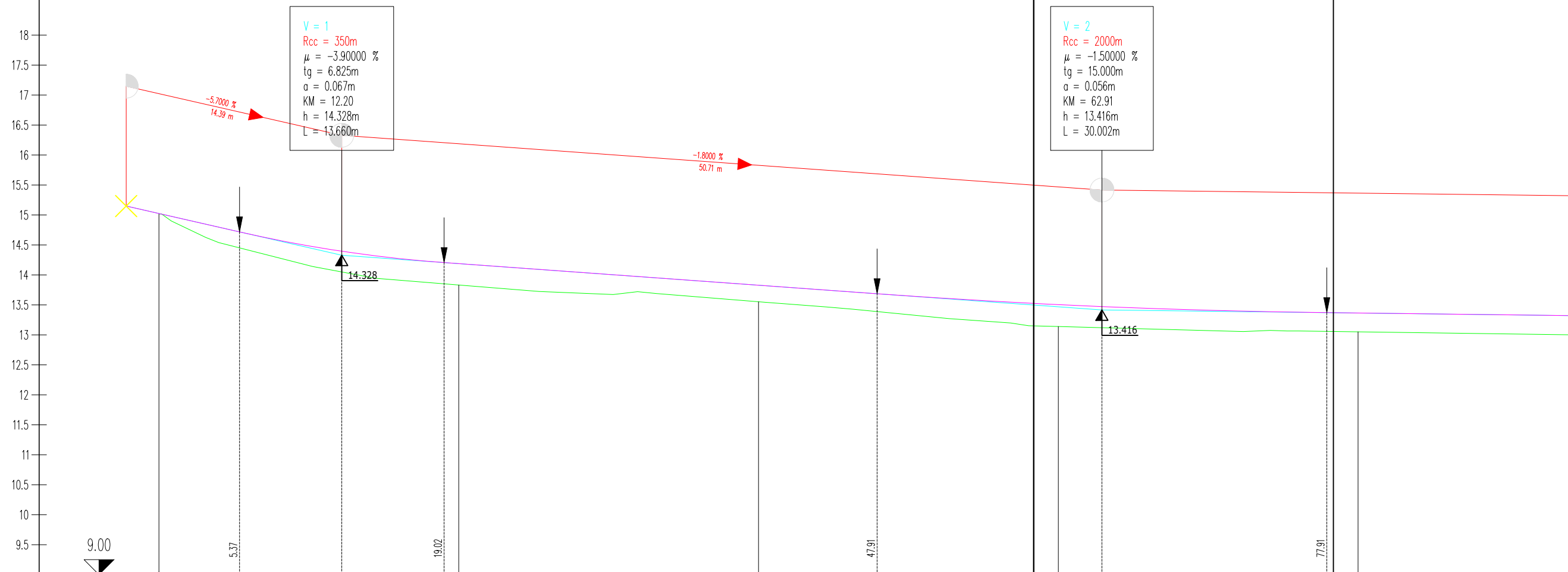

SECTION-1: OP-1
 SCALE 1:200/50



| | | | | | | | | | | |
|----------------------|------------------|--------|--------|--------|--------|--------|--------|--------|---------------------|--------|
| CROSS-SECTION NUMBER | PT1 | 20.000 | PT2 | 20.000 | PT3 | 20.000 | PT4 | 20.000 | PT5 | 20.000 |
| STATION | 0.00 | | 20.00 | | 40.00 | | 60.00 | | 80.00 | |
| TERRAIN ELEVATION | 15.017 | | 13.832 | | 13.552 | | 13.139 | | 13.051 | |
| ALIGNMENT ELEVATION | 15.149 15.024 | | 14.188 | | 13.828 | | 13.505 | | 13.364 | |
| HORIZONTAL ELEMENTS | Right Left | Curve | | | | | | | Tangent l=164.88 | |

Porositi:

 Bashkia Shkoder

Projektoi:
"LENI-ING" sh.p.k
 Administrator Ing.Nikoll Paluca
 Adresa: Tirane
 Mobile: 068 20 42 270
 Email: leni.ing@hotmail.com

Objekti: Sistemim - Asfaltim i rrugës Oblike - Pallate
 Faza: **Projekt - Zbatimi**
 Emërtimi i Fletës: PROFILI GJATESORE
 Shkalla: Sh-1:150
 Tiranë 2021
 PGJ-01

PROFILI GJATESORE

AKSI 1

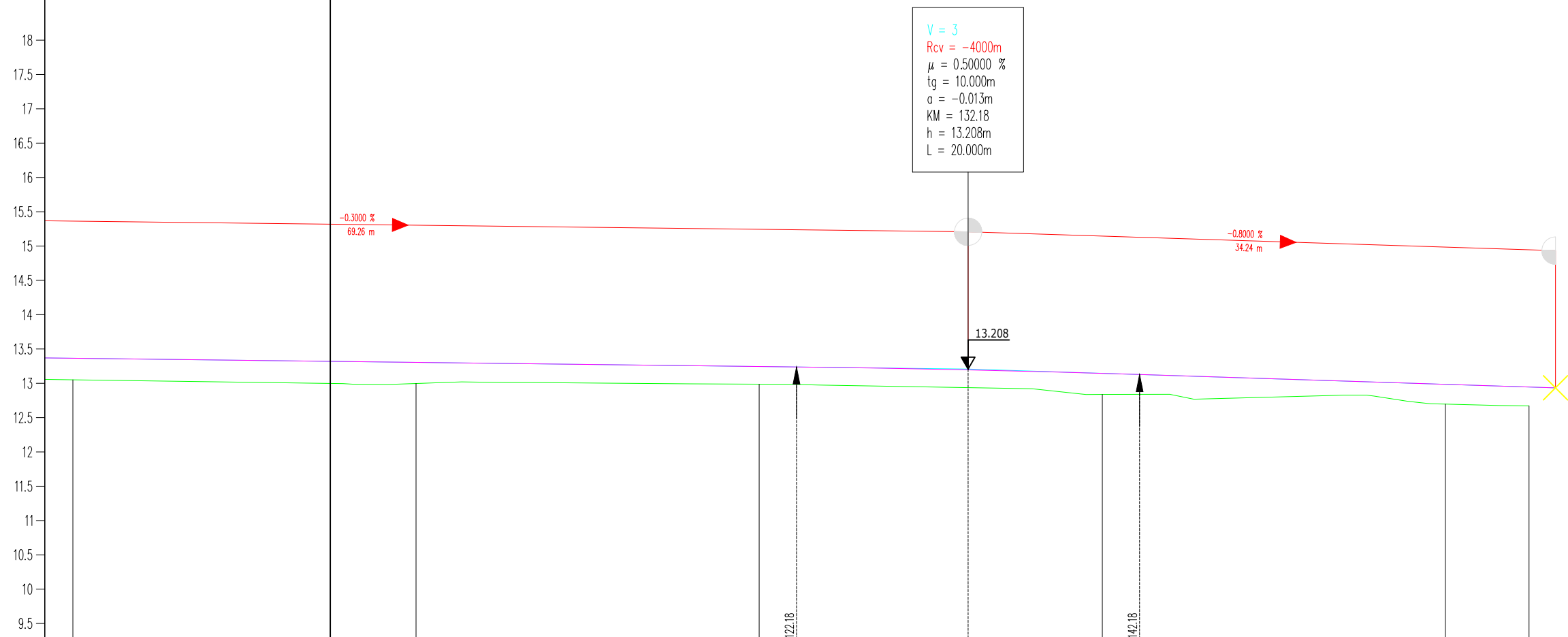

SECTION-1: OP-1
SCALE 1:200/50



| | | | | | | | | | | | |
|----------------------|---------------------|--------|--------|--------|--------|--------|--------|--------|--------|-------|------------------|
| CROSS-SECTION NUMBER | PT5 | 20.000 | PT6 | 20.000 | PT7 | 20.000 | PT8 | 20.000 | PT9 | 4.876 | PT10 |
| STATION | 80.00 | | 000 | | 20.00 | | 40.00 | | 60.00 | | 64.87 |
| TERRAIN ELEVATION | 13.051 | | 12.997 | | 12.988 | | 12.837 | | 12.696 | | 12.671 |
| ALIGNMENT ELEVATION | 13.364 | | 13.304 | | 13.244 | | 13.145 | | 12.985 | | 12.946 12.934 |
| HORIZONTAL ELEMENTS | Tangent l=164.88 | | | | | | | | | | |

Porositi:



Bashkia Shkoder

Projektoi:

"LENI-ING" sh.p.k

Administrator Ing.Nikoll Paluca

Adresa: Tirane

Mobile: 068 20 42 270

Email: leni.ing@hotmail.com

Objekti: Sistemim - Asfaltim i rrugës Oblike - Pallate

Faza:

Projekt - Zbatimi

Emërtimi i Fletës:

PROFILI
GJATESORE

Shkalla:

Sh-1:150

Tiranë 2021

PGJ-02

PROFILI GJATESORE

AKSI 2

SECTION-2: OP-2
SCALE 1:200/50

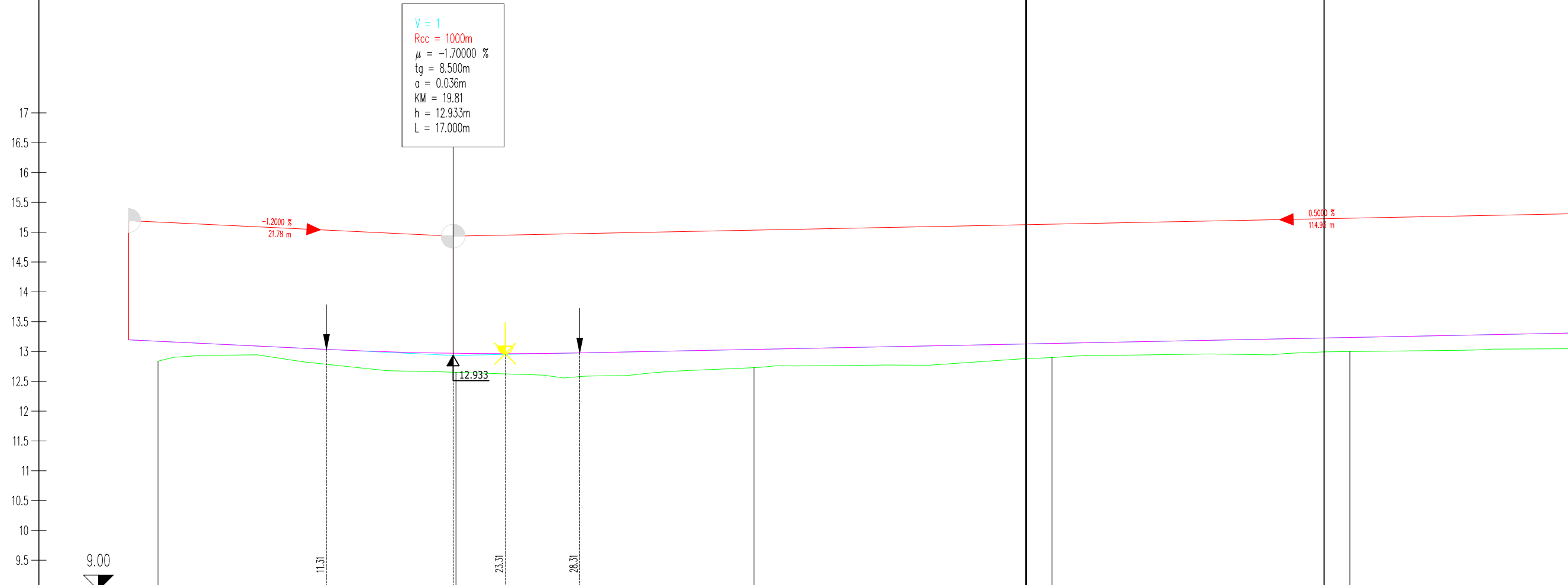

| | | | | | | | | | | |
|----------------------|------------------|--------|--------------------|--------|-------------------|--------|--------------------|--------|--------|--------|
| CROSS-SECTION NUMBER | PT11 | 20.000 | PT12 | 20.000 | PT13 | 20.000 | PT14 | 20.000 | PT15 | 20.000 |
| STATION | 0.00 | | 20.00 | | 40.00 | | 60.00 | | 80.00 | |
| TERRAIN ELEVATION | 12.838 | | 12.650 | | 12.728 | | 12.899 | | 12.999 | |
| ALIGNMENT ELEVATION | 13.195 13.171 | | 12.969 | 12.969 | 13.014 13.034 | | 13.134 | | 13.234 | |
| HORIZONTAL ELEMENTS | Right Left | Curve | Tangent l=26.71 | | R=-6.25 l=9.18 | | Tangent l=72.82 | | | |

| | | | | |
|--|---|----------------------|--|--|
| Porositi:  Bashkia Shkoder | Projektoi: "LENI-ING" sh.p.k Administrator Ing.Nikoll Paluca Adresa: Tirane Mobile: 068 20 42 270 Email: leni.ing@hotmail.com | | Objekti: Sistemim - Asfaltim i rrugës Oblike - Pallate | |
| | Faza: Projekt - Zbatimi | | | |
| | Emërtimi i Fletës: PROFILI GJATESORE | Shkalla: Sh-1:150 | Tiranë 2021 PGJ-03 | |

PROFILI GJATESORE

AKSI 2

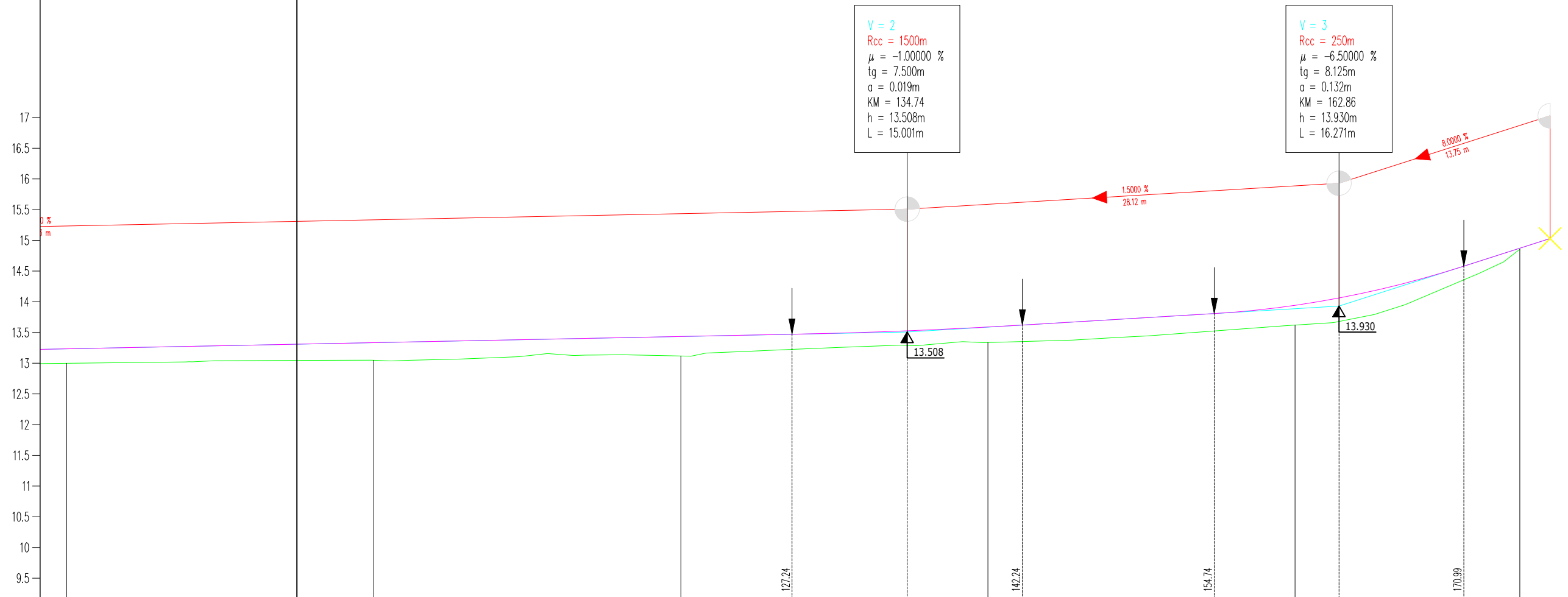

SECTION-2: OP-2
 SCALE 1:200/50

| | | | | | | | | | | | |
|----------------------|---|--------|--------|--------|--------|--------|--------|--------|--------|--------|------------------|
| CROSS-SECTION NUMBER | PT15 | 20.000 | PT16 | 20.000 | PT17 | 20.000 | PT18 | 20.000 | PT19 | 14.638 | PT20 |
| STATION | 80.00 | | 000 | | 20.00 | | 40.00 | | 60.00 | | 74.63 |
| TERRAIN ELEVATION | 12.999 | | 13.048 | | 13.117 | | 13.337 | | 13.621 | | 14.856 |
| ALIGNMENT ELEVATION | 13.234 | | 13.334 | 13.378 | 13.434 | 13.490 | 13.589 | | 13.942 | | 14.872 15.030 |
| HORIZONTAL ELEMENTS | <p>Tangent l=44.16</p> <p>R=-200.00 l=21.76</p> | | | | | | | | | | |



| | | | |
|---|---|--|----------------------|
| Porositi: Bashkia Shkoder | Projektoi: "LENI-ING" sh.p.k Administrator Ing.Nikoll Paluca Adresa: Tirane Mobile: 068 20 42 270 Email: leni.ing@hotmail.com | Objekti: Sistemim - Asfaltim i rrugës Oblike - Pallate | |
| | | Faza: Projekt - Zbatimi | |
| | | Emërtimi i Fletës: PROFILI GJATESORE | Shkalla: Sh-1:150 |

PROFILI GJATESORE

AKSI 3

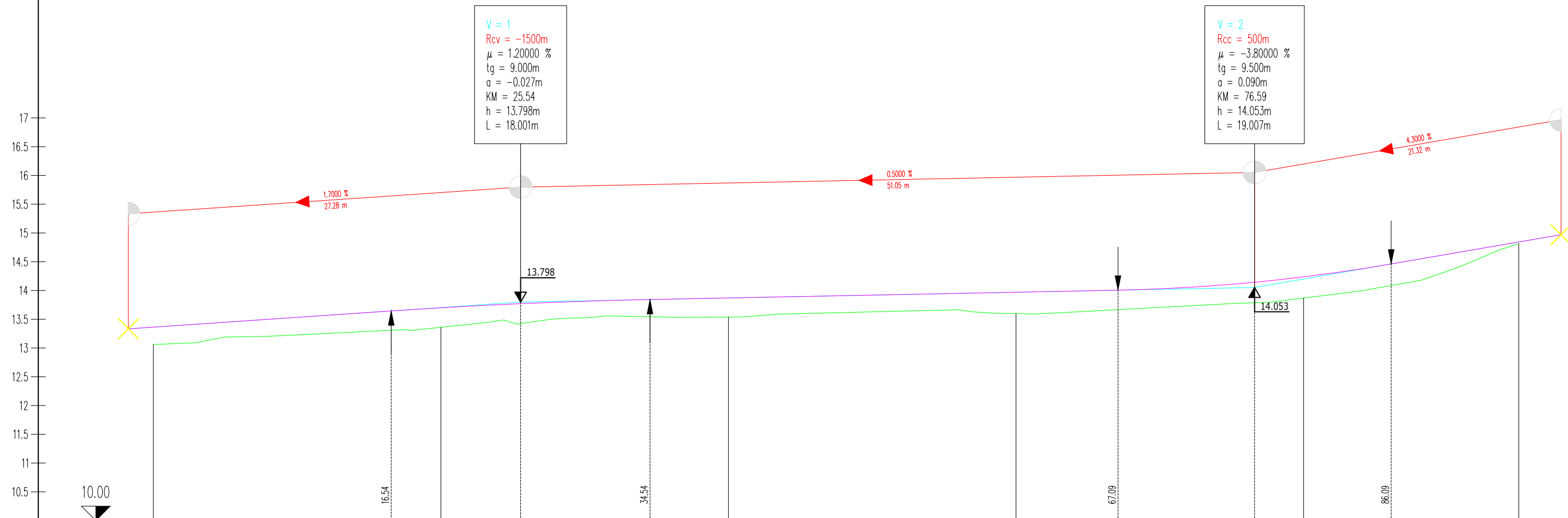

SECTION-3: OP-3
SCALE 1:200/50

| | | | | | | | | | | | |
|----------------------|------------------|--------|--------------------|----------------------------|--------------------|------------------------------|--------------------|--------|--------|--------|------------------|
| CROSS-SECTION NUMBER | PT21 | 20.000 | PT22 | 20.000 | PT23 | 20.000 | PT24 | 20.000 | PT25 | 14.970 | PT26 |
| STATION | -0.00 | | 20.00 | | 40.00 | | 60.00 | | 80.00 | | 94.96 |
| TERRAIN ELEVATION | 13.063 | | 13.359 | | 13.538 | | 13.598 | | 13.869 | | 14.817 |
| ALIGNMENT ELEVATION | 13.334 13.363 | | 13.699 13.736 | | 13.818 | | 13.969 13.970 | | 14.236 | | 14.843 14.969 |
| HORIZONTAL ELEMENTS | Right Left | Curve | Tangent l=22.67 | Curve R=-5.25 l=7.93 | Tangent l=27.27 | Curve R=-200.00 l=8.71 | Tangent l=28.39 | | | | |

Porositi:



Bashkia Shkoder

Projektoi:

"LENI-ING" sh.p.k

Administrator Ing.Nikoll Paluca

Adresa: Tirane
Mobile: 068 20 42 270
Email: leni.ing@hotmail.com

Objekti: Sistemim - Asfaltim i rrugës Oblike - Pallate

Faza: **Projekt - Zbatimi**

| | | |
|--------------------|----------|-------------|
| Emërtimi i Fletës: | Shkalla: | Tiranë 2021 |
| PROFILI GJATESORE | Sh-1:150 | PGJ-05 |

PROFILAT TERHORE

AKSI 1

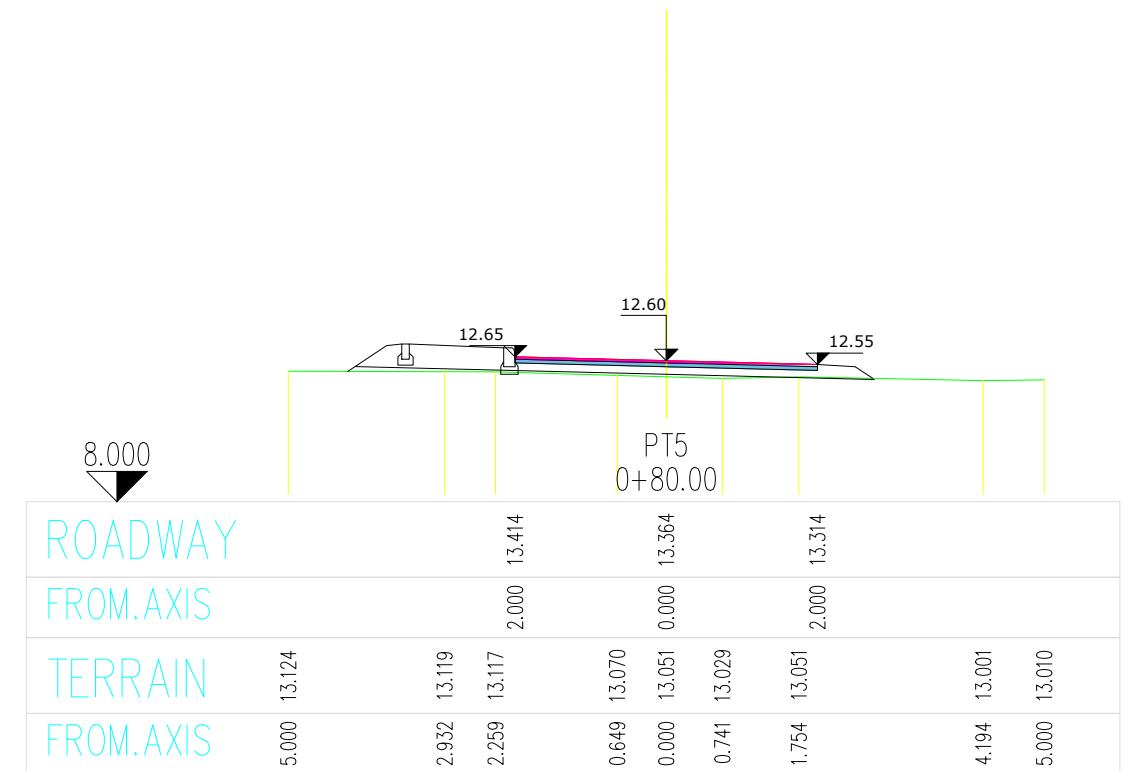
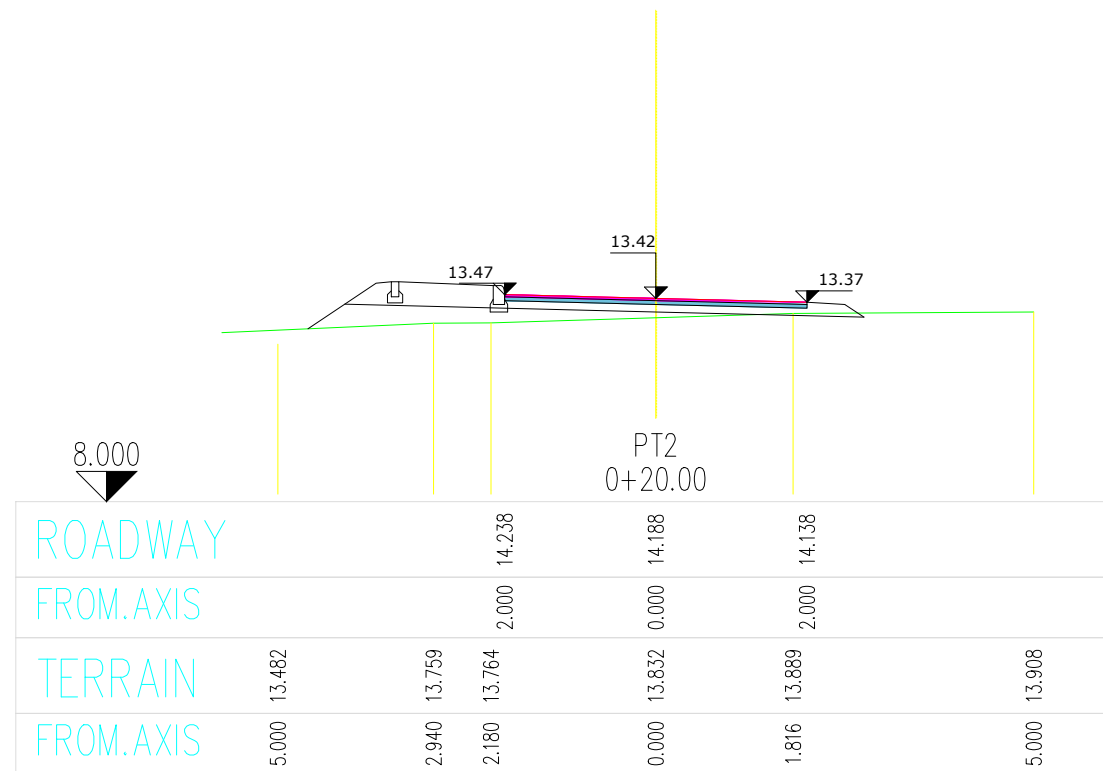
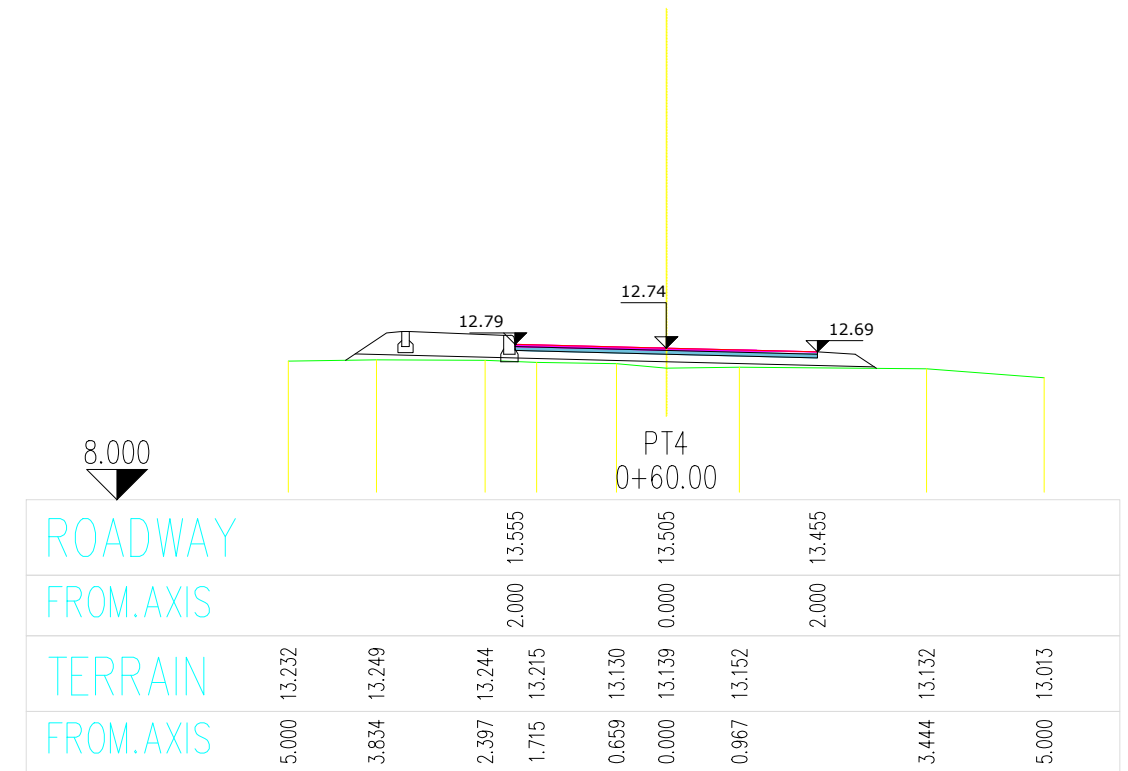
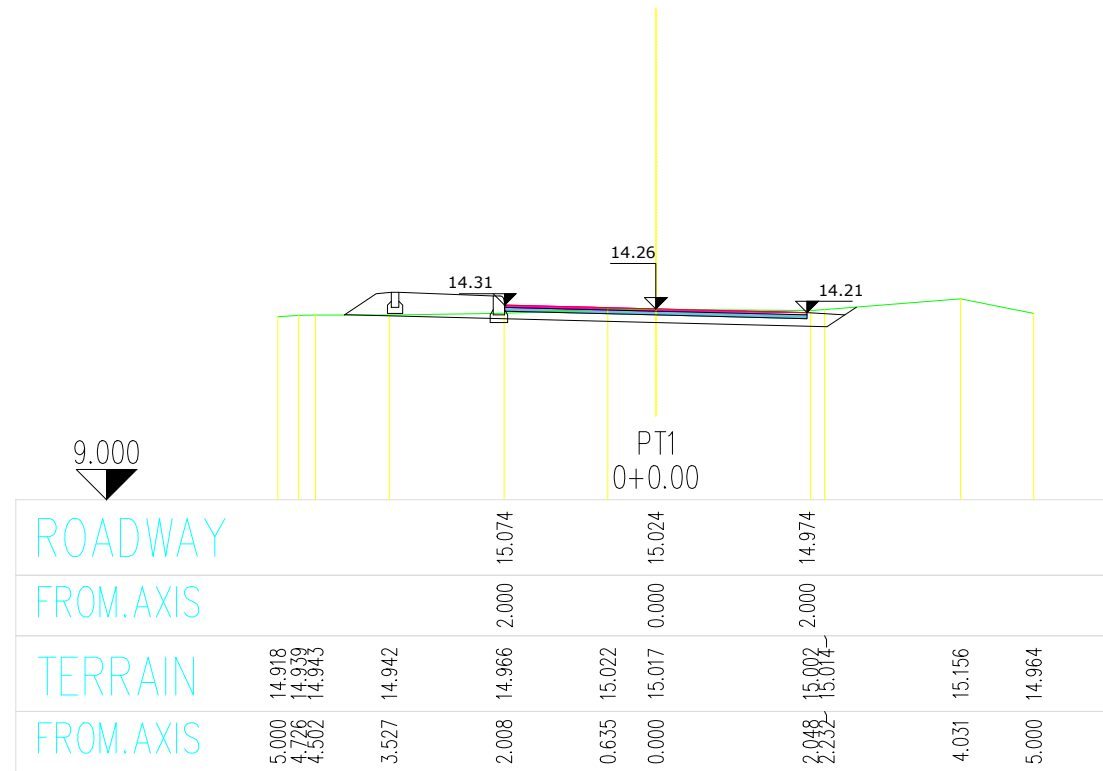

Porositi:



Bashkia Shkoder

Projektoi:

"LENI-ING" sh.p.k

Administrator Ing.Nikoll Paluca

Adresa: Tirane

Mobile: 068 20 42 270

Email: leni.ing@hotmail.com

Objekti: Sistemim - asfaltim i rrugës Oblike Pallate

Faza: **Projekt - Zbatimi**

Emërtimi i Fletës:

**PROFILAT
TERTHORE AKSI 1**

Shkalla:

Sh-1:100

Tiranë 2021

PT - 01

PROFILAT TERHORE

AKSI 1

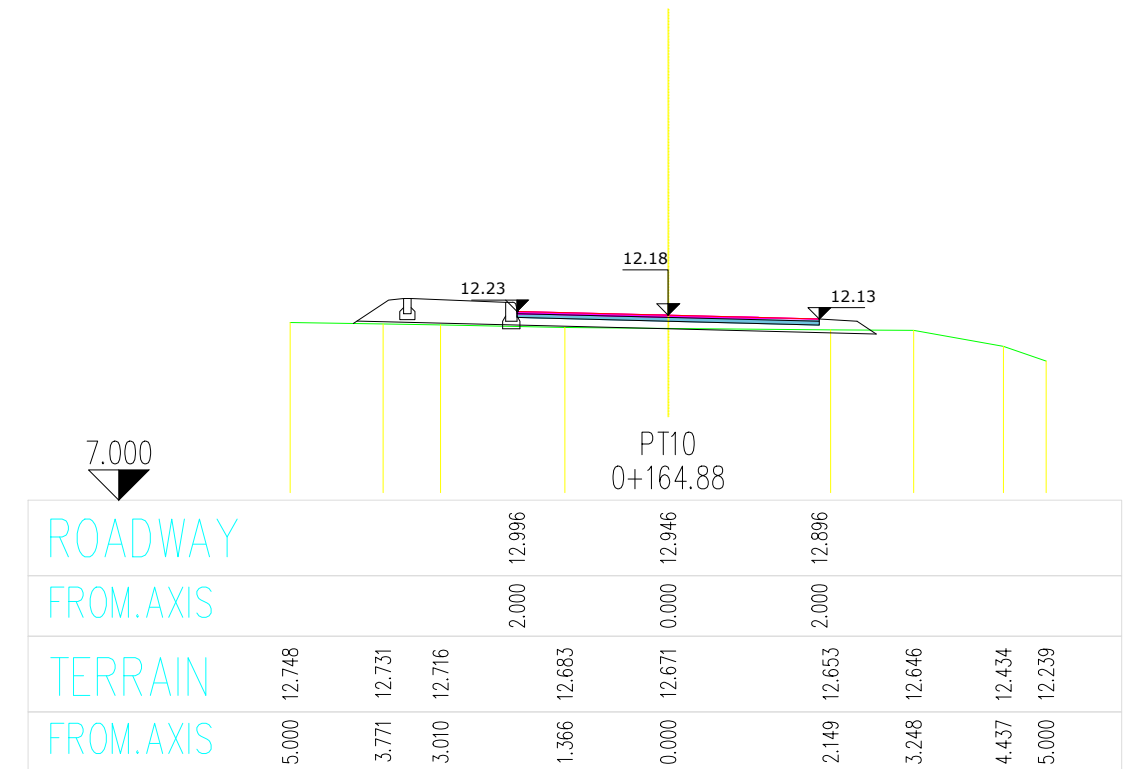
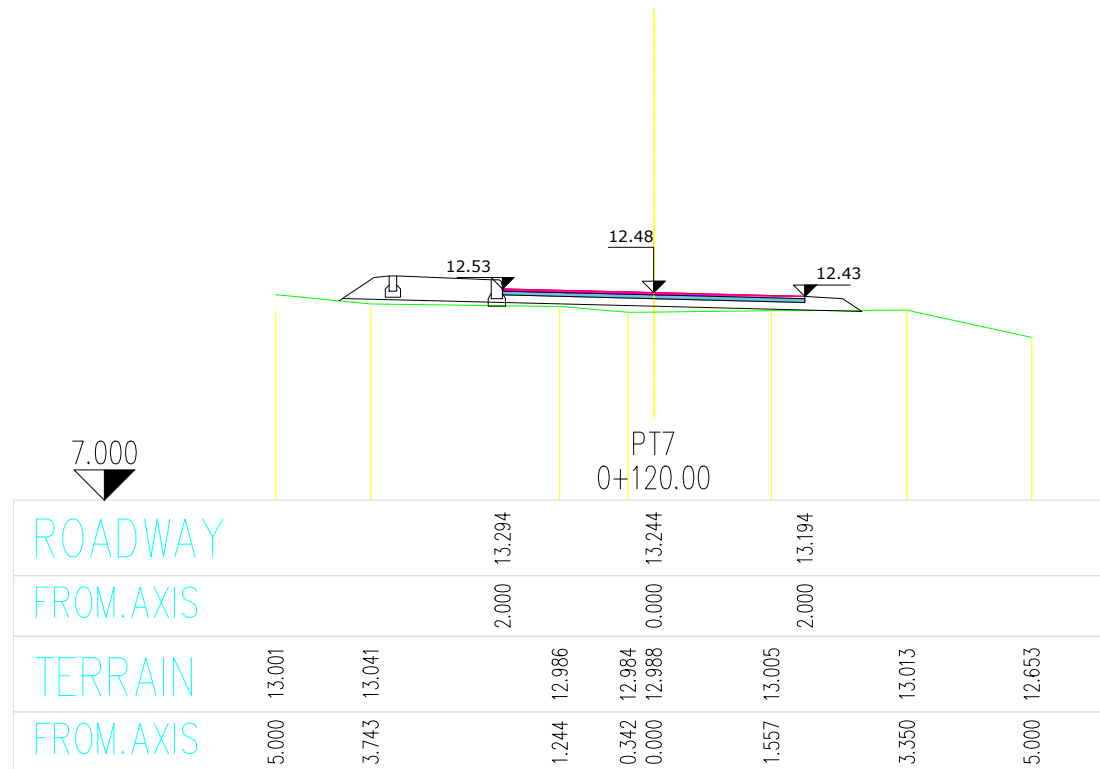
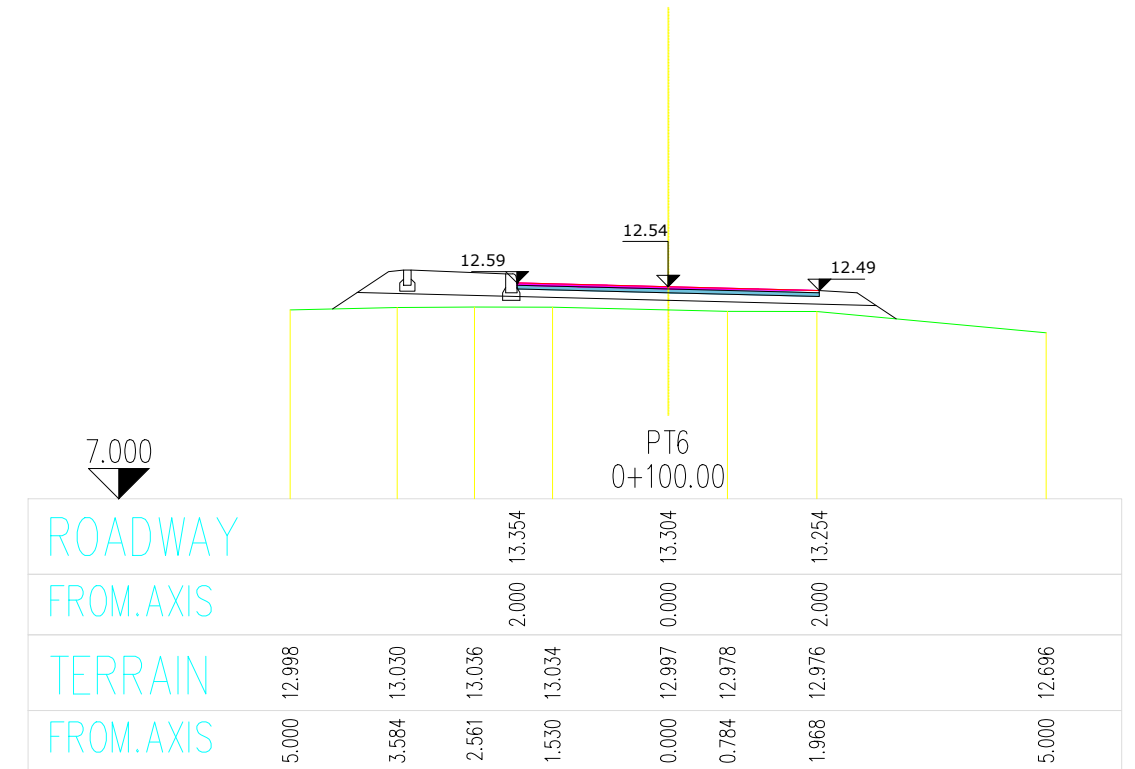
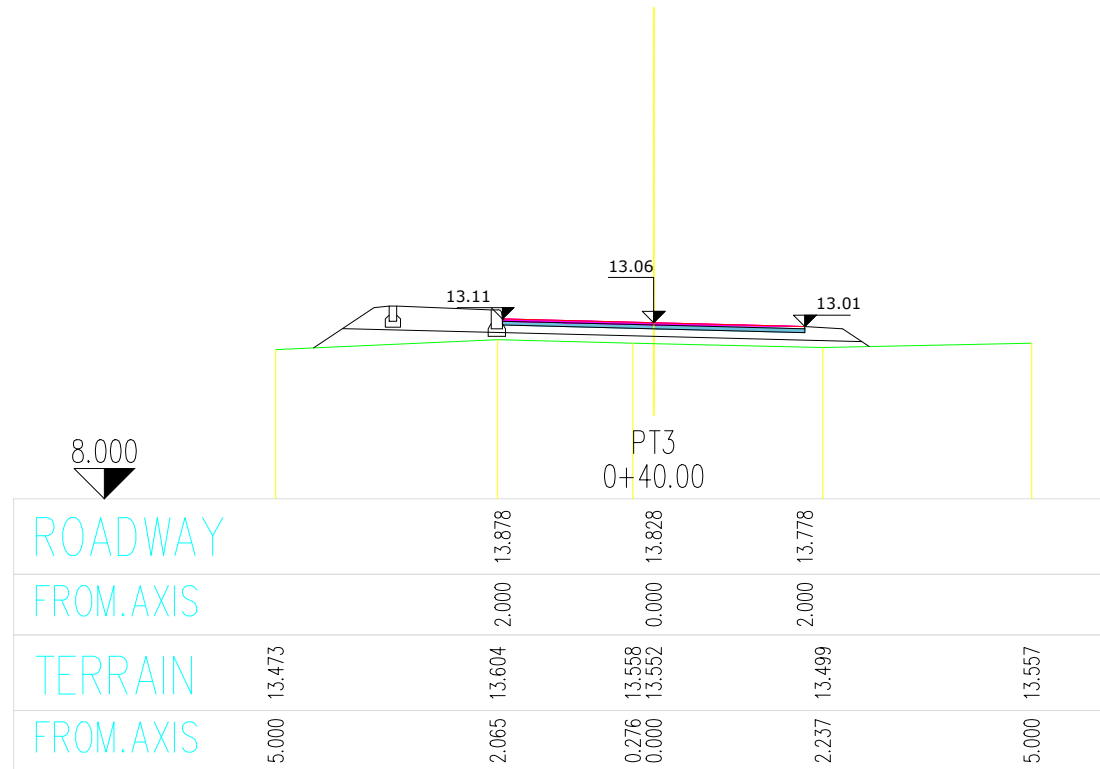

Porositi:



Bashkia Shkoder

Projektoi:

"LENI-ING" sh.p.k

Administrator Ing.Nikoll Paluca

Adresa: Tirane

Mobile: 068 20 42 270

Email: leni.ing@hotmail.com

Objekti: Sistemim - asfaltim i rrugës Oblike Qendër - Lagjja Lami dhe Rrashkej

Faza: **Projekt - Zbatimi**

Emërtimi i Fletës:

**PROFILAT
TERTHORE AKSI 1**

Shkalla:

Sh-1:100

Tiranë 2021

PT - 02

PROFILAT TERHORE

AKSI 1

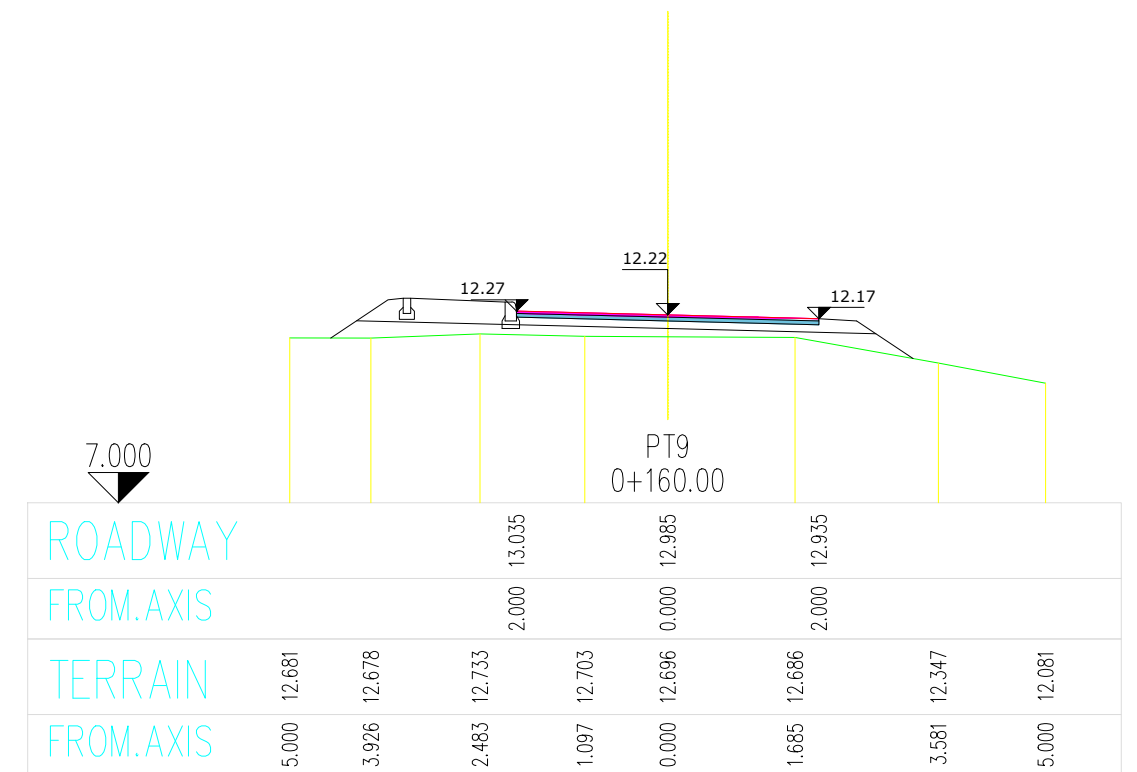
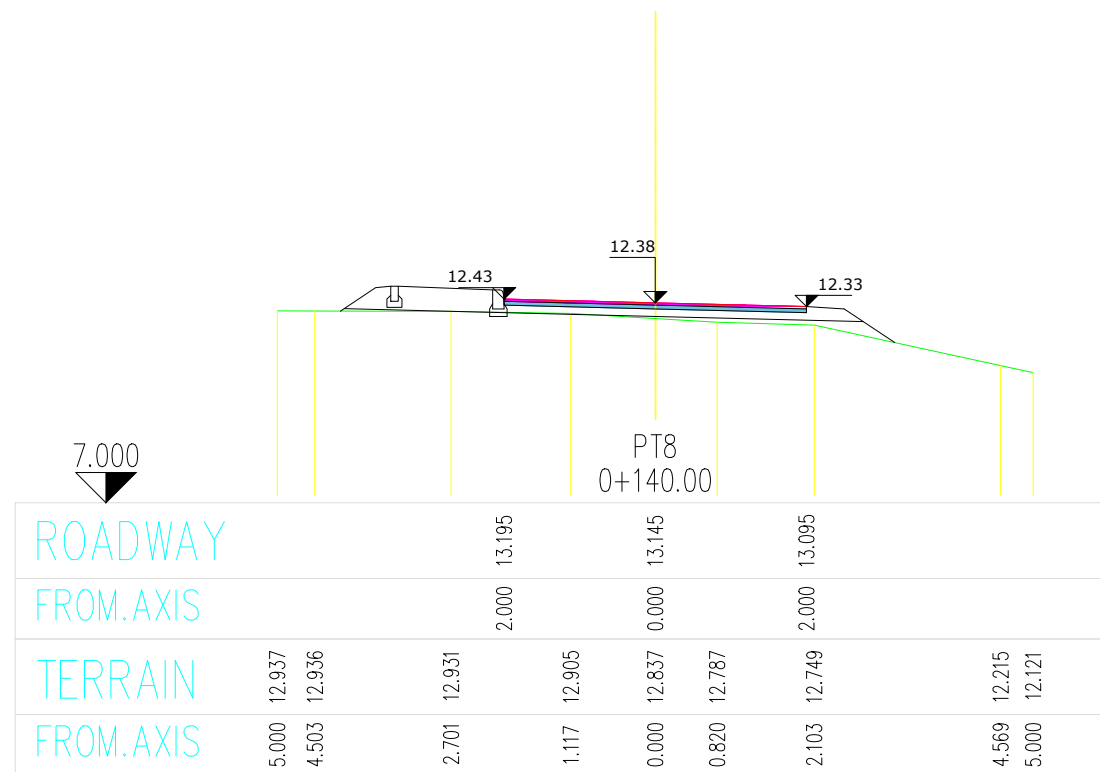

Porositi:



Bashkia Shkoder

Projektoi:

"LENI-ING" sh.p.k

Administrator Ing.Nikoll Paluca

Adresa: Tirane

Mobile: 068 20 42 270

Email: leni.ing@hotmail.com

Objekti: Sistemim - asfaltim i rrugës Oblike Qendër - Lagjja Lami dhe Rrashkej

Faza: **Projekt - Zbatimi**

Emërtimi i Fletës:

**PROFILAT
TERTHORE AKSI 1**

Shkalla:

Sh-1:100

Tiranë 2021

PT - 03

PROFILAT TERHORE

AKSI 2

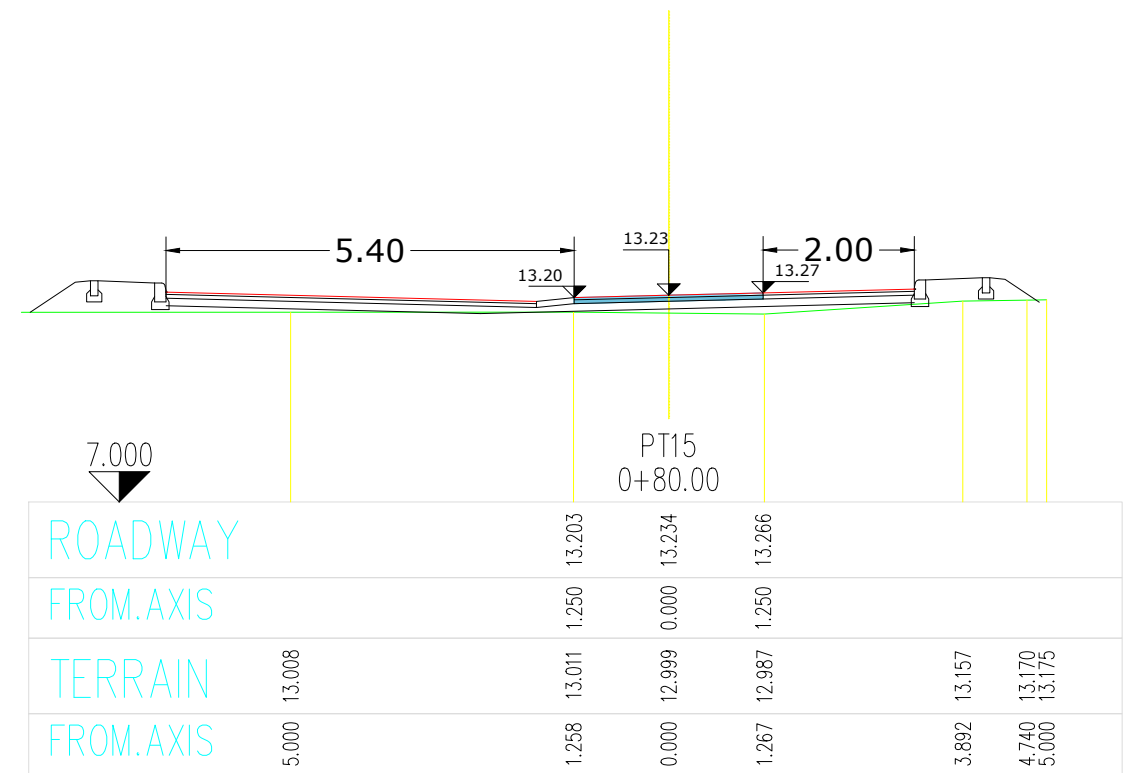
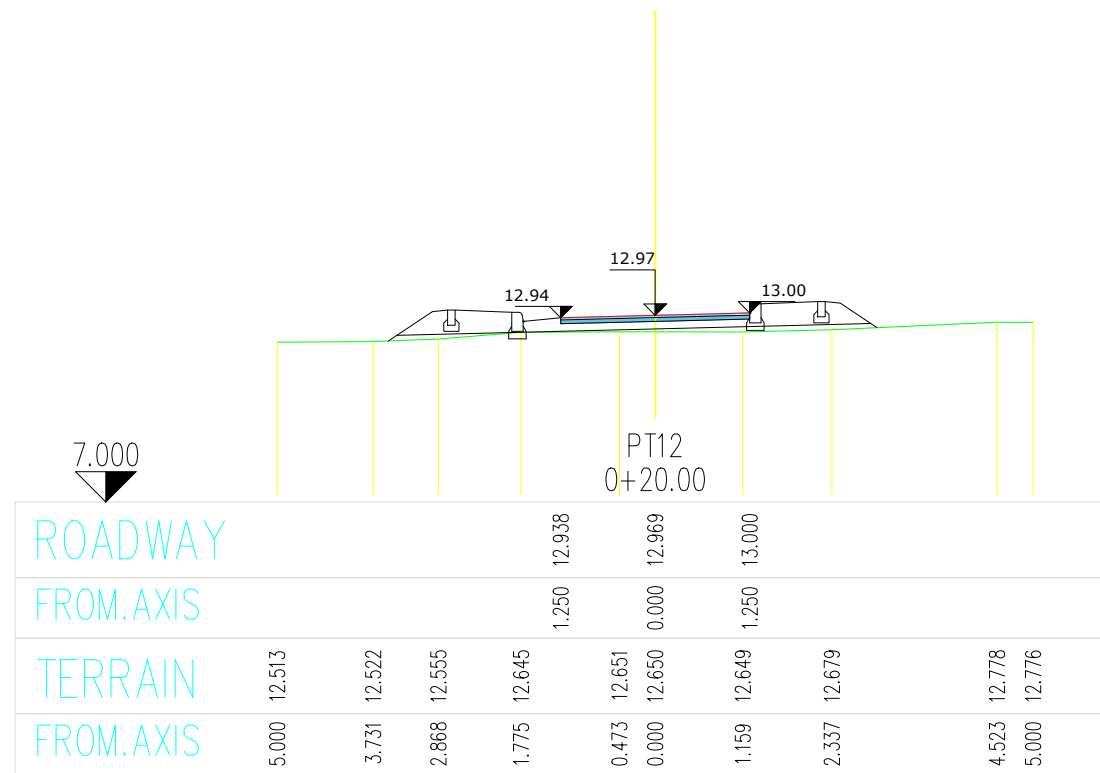
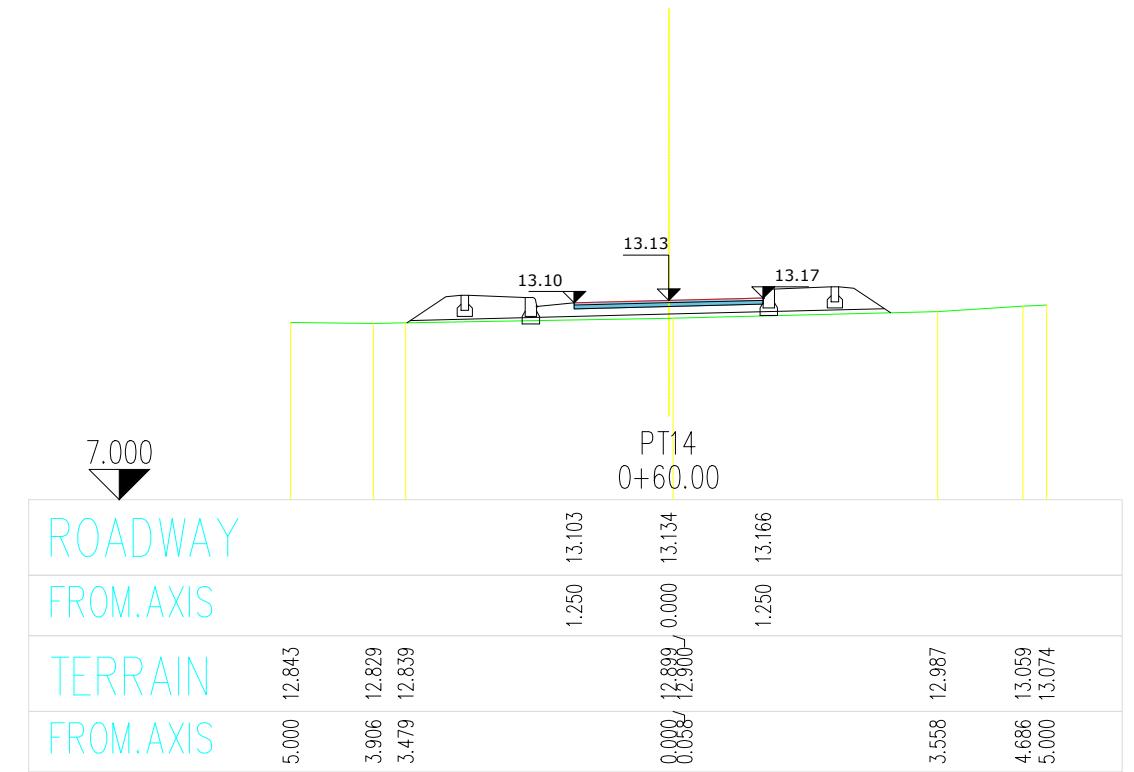
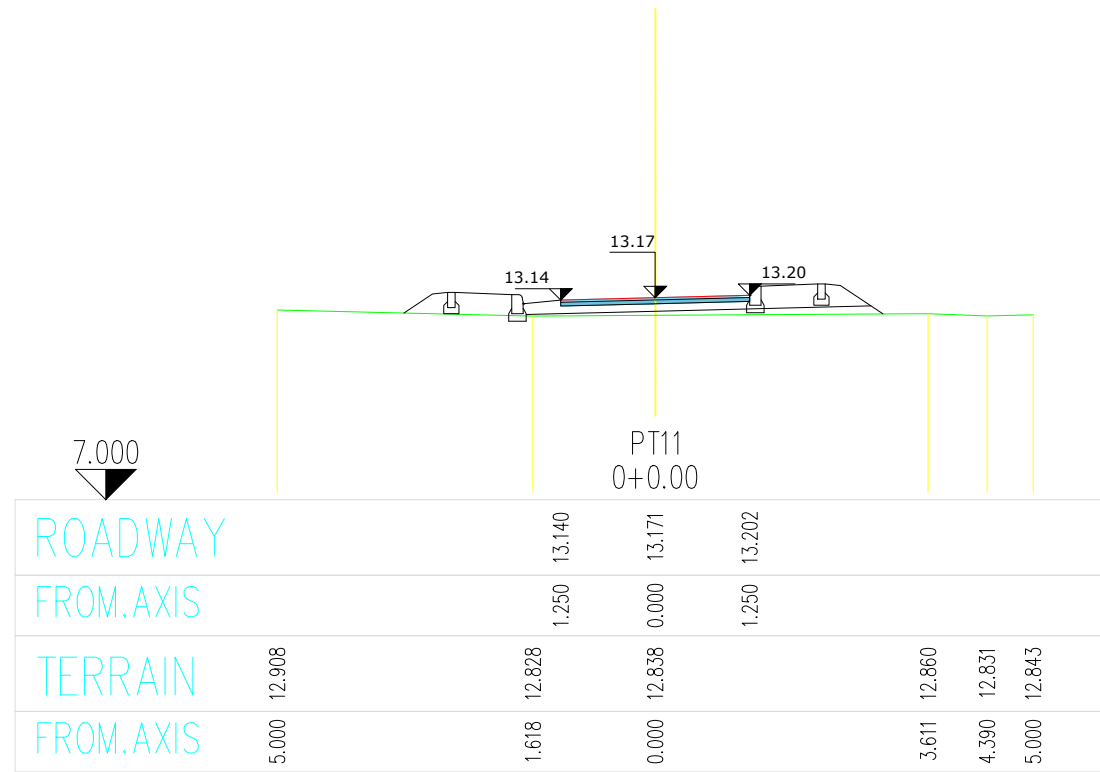

Porositi:



Bashkia Shkoder

Projektoi:

"LENI-ING" sh.p.k

Administrator Ing.Nikoll Paluca

Adresa: Tirane

Mobile: 068 20 42 270

Email: leni.ing@hotmail.com

Objekti: Sistemim - asfaltim i rruges Oblike Qendër - Lagjja Lami dhe Rrashkej

Faza: **Projekt - Zbatimi**

Emërtimi i Fletës:

**PROFILAT
TERTHORE AKSI 2**

Shkalla:

Sh-1:100

Tiranë 2021

PT - 04

PROFILAT TERHORE

AKSI 2

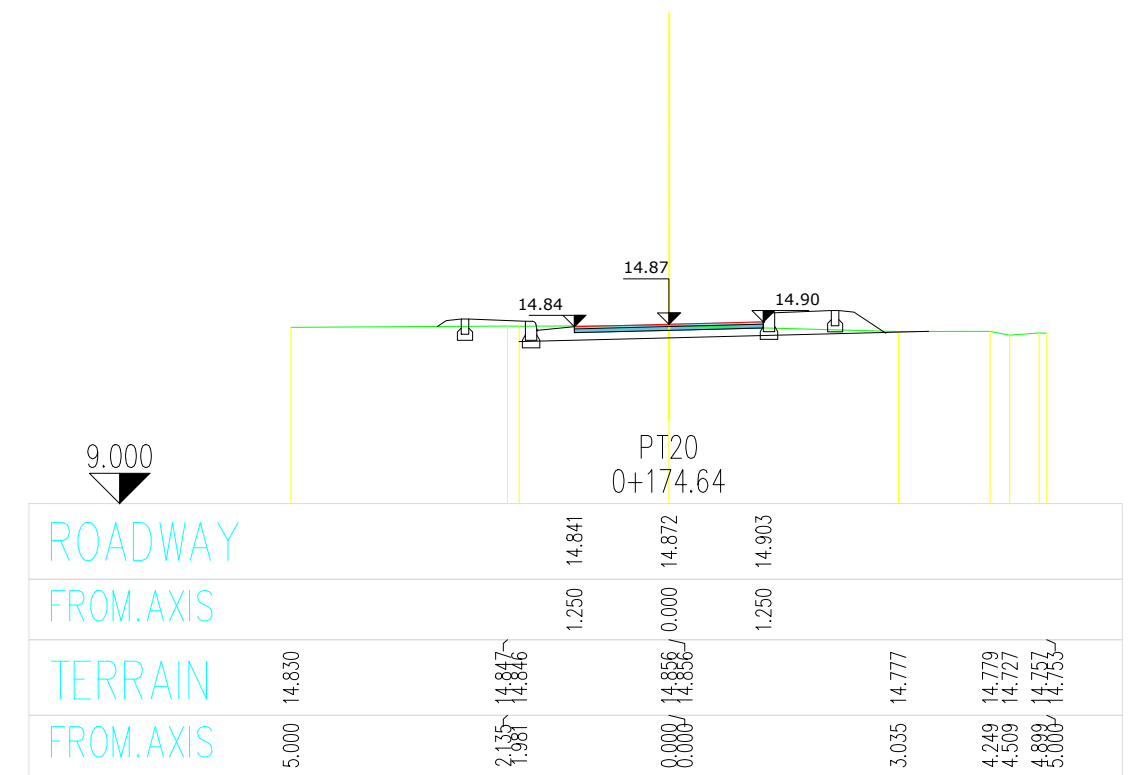
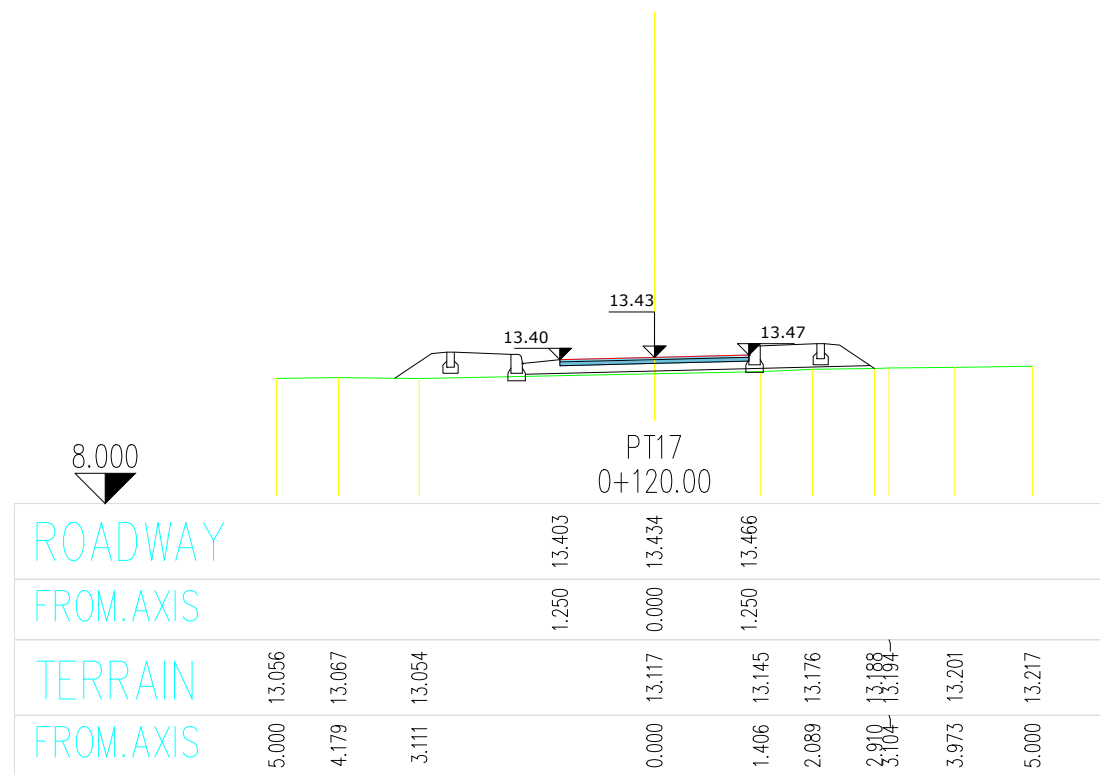
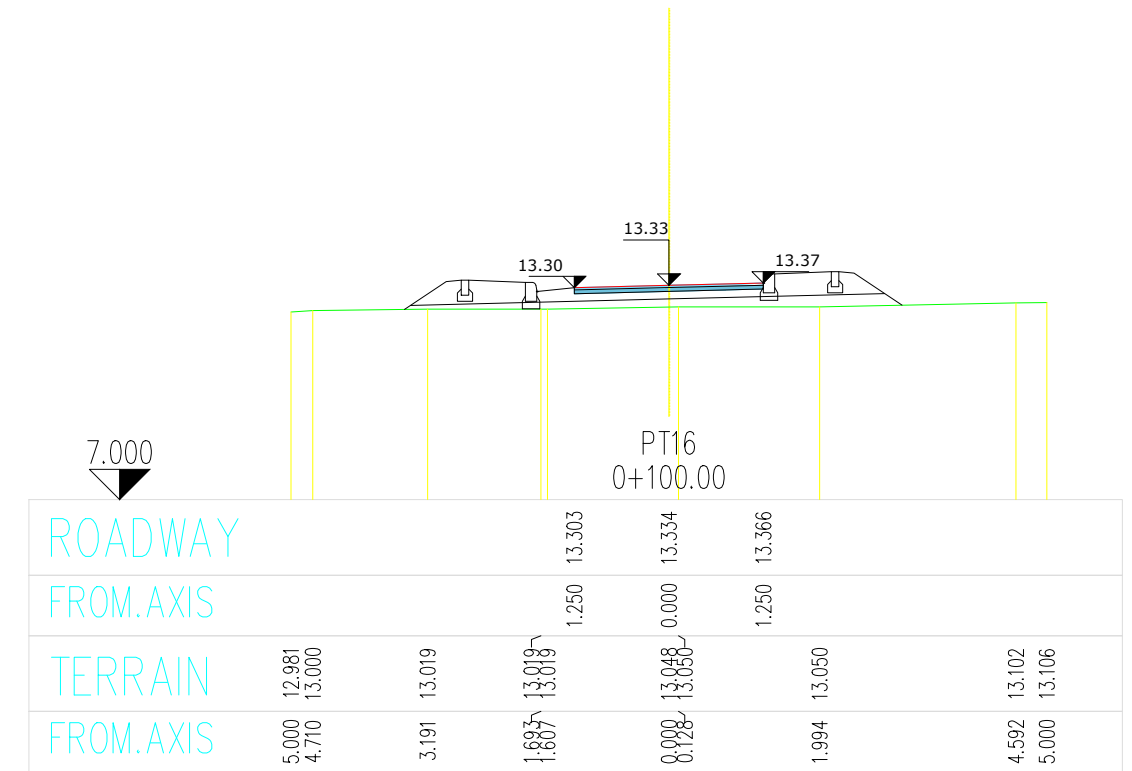
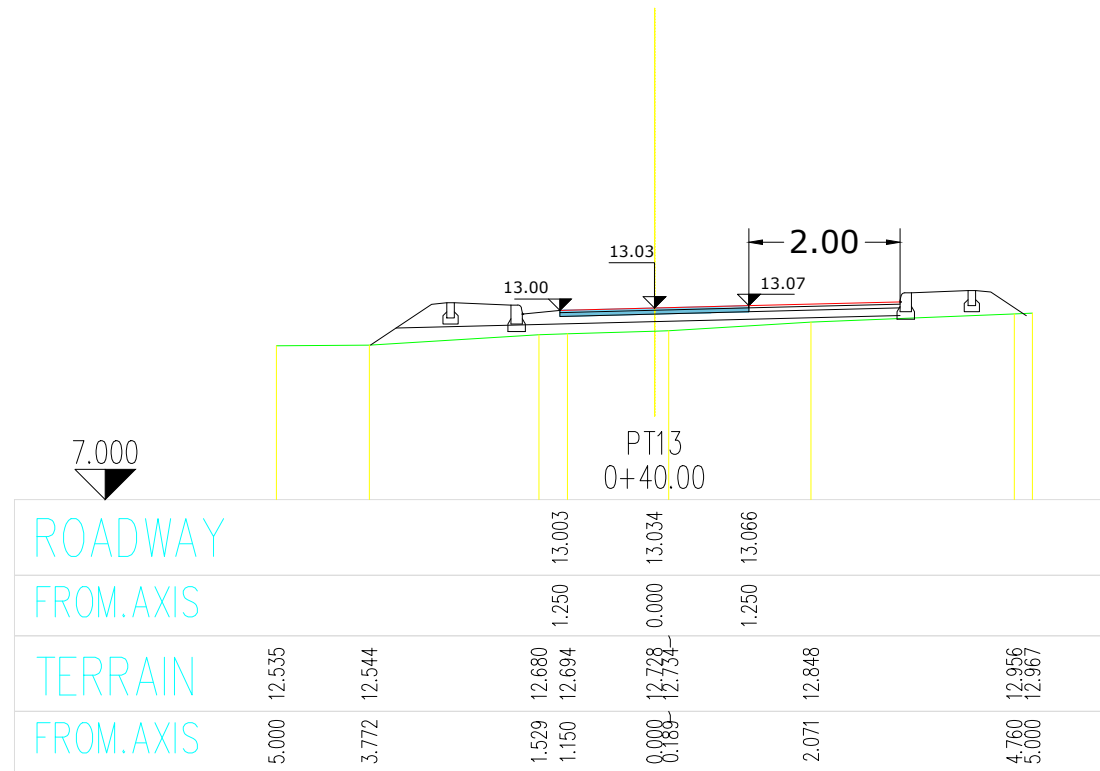

Porositi:



Bashkia Shkoder

Projektoi:

"LENI-ING" sh.p.k

Administrator Ing.Nikoll Paluca

Adresa: Tirane
Mobile: 068 20 42 270
Email: leni.ing@hotmail.com

Objekti: Sistemim - asfaltim i rrugës Oblike Qendër - Lagjja Lami dhe Rrashkej

Faza: **Projekt - Zbatimi**

| | | |
|---------------------------------|----------|-------------|
| Emërtimi i Fletës: | Shkalla: | Tiranë 2021 |
| PROFILAT TERTHORE AKSI 2 | Sh-1:100 | PT - 05 |

PROFILAT TERHORE

AKSI 2

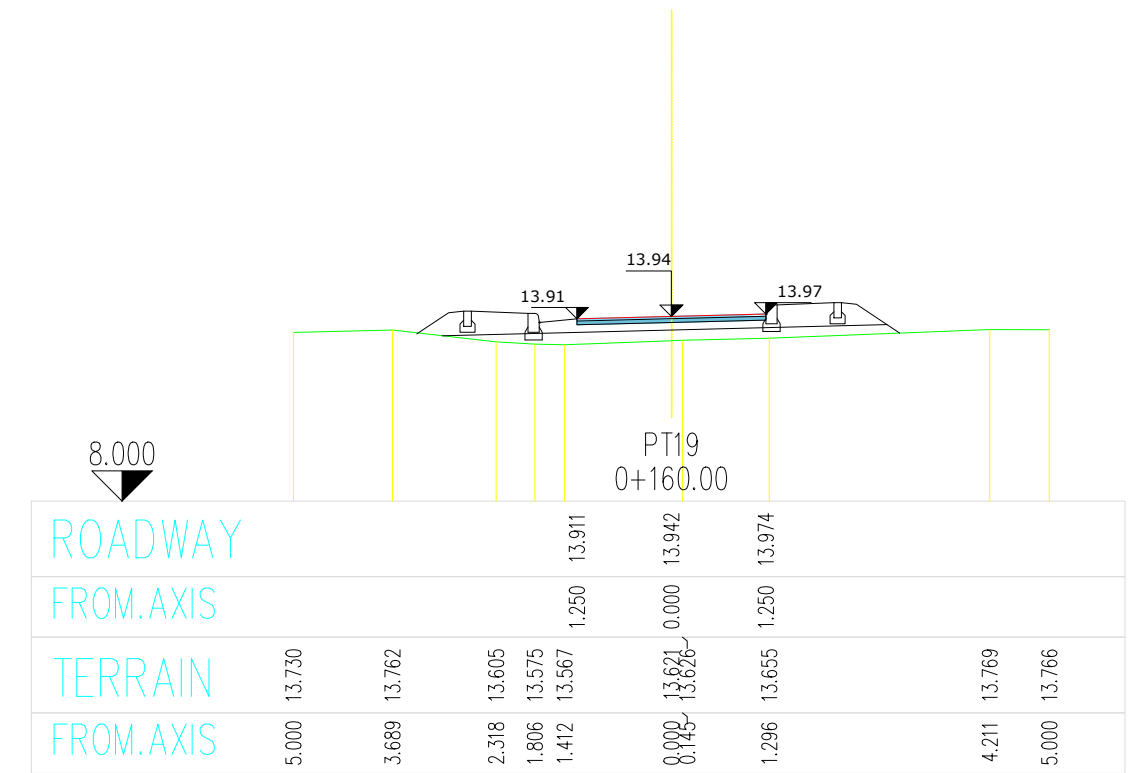
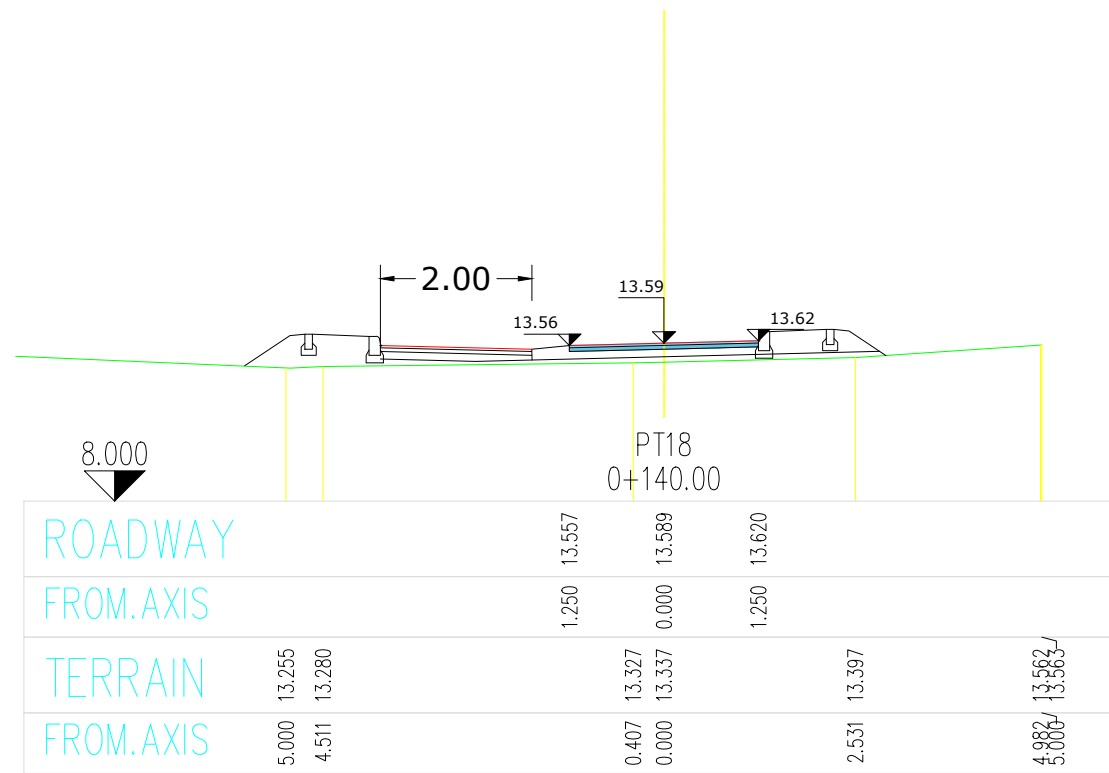

Porositi:



Bashkia Shkoder

Projektoi:

"LENI-ING" sh.p.k

Administrator Ing.Nikoll Paluca

Adresa: Tirane

Mobile: 068 20 42 270

Email: leni.ing@hotmail.com

Objekti: Sistemim - asfaltim i rrugës Oblike Qendër - Lagjja Lami dhe Rrashkej

Faza: **Projekt - Zbatimi**

Emërtimi i Fletës:

PROFILAT
TERTHORE AKSI 2

Shkalla:

Sh-1:100

Tiranë 2021

PT - 06

PROFILAT TERHORE

AKSI 3

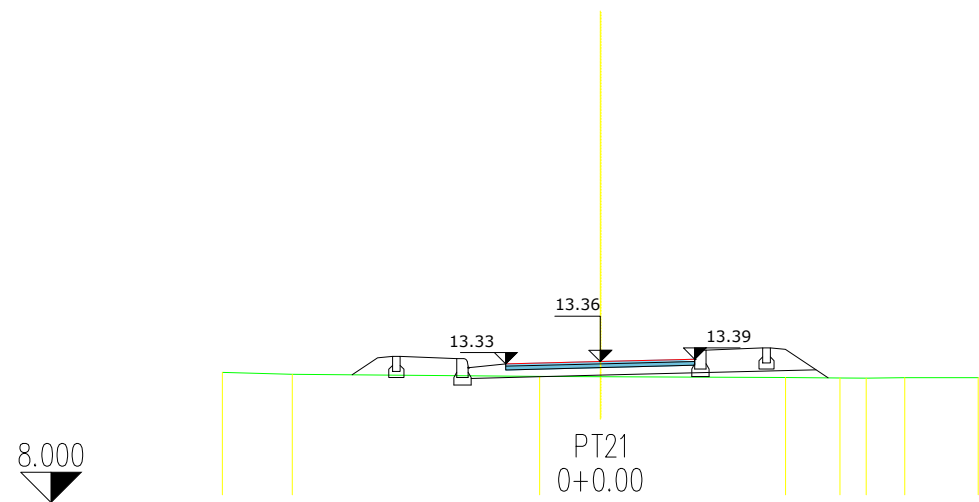

| | | | | | |
|-----------|--------|--------|--------|--------|--------|
| ROADWAY | | 13.332 | 13.363 | 13.395 | |
| FROM.AXIS | | 1.250 | 0.000 | 1.250 | |
| TERRAIN | 13.119 | 13.095 | 13.067 | 13.063 | 13.052 |
| FROM.AXIS | 5.000 | 4.074 | 0.801 | 0.000 | 2.452 |

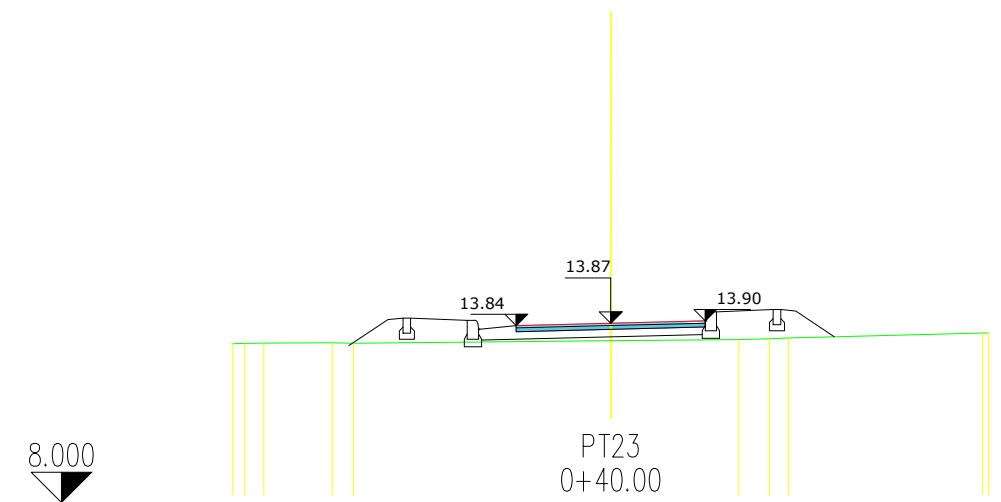

| | | | | | |
|-----------|--------|--------|--------|--------|--------|
| ROADWAY | | 13.839 | 13.870 | 13.901 | |
| FROM.AXIS | | 1.250 | 0.000 | 1.250 | |
| TERRAIN | 13.499 | 13.503 | 13.511 | 13.506 | 13.555 |
| FROM.AXIS | 5.000 | 4.844 | 3.686 | 0.000 | 1.693 |

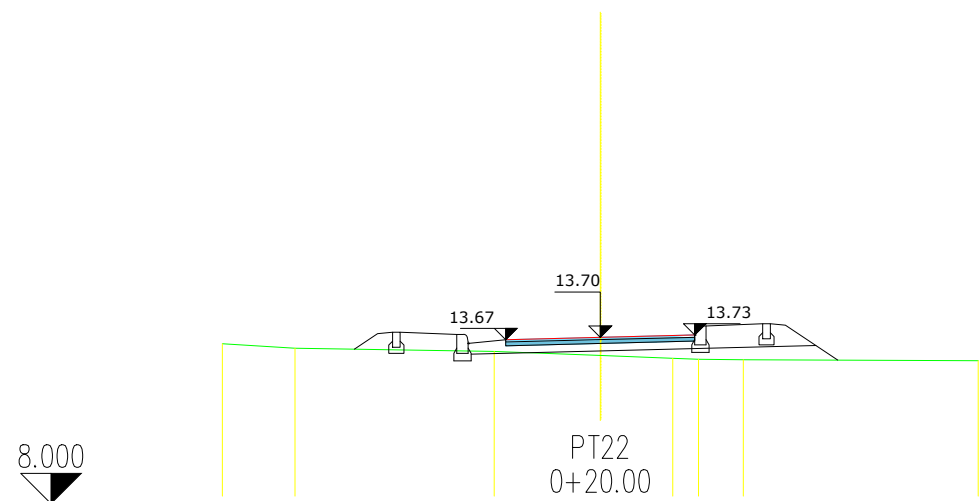

| | | | | | |
|-----------|--------|--------|--------|--------|--------|
| ROADWAY | | 13.668 | 13.699 | 13.731 | |
| FROM.AXIS | | 1.250 | 0.000 | 1.250 | |
| TERRAIN | 13.516 | 13.457 | 13.414 | 13.359 | 13.322 |
| FROM.AXIS | 5.000 | 4.038 | 1.404 | 0.000 | 0.959 |

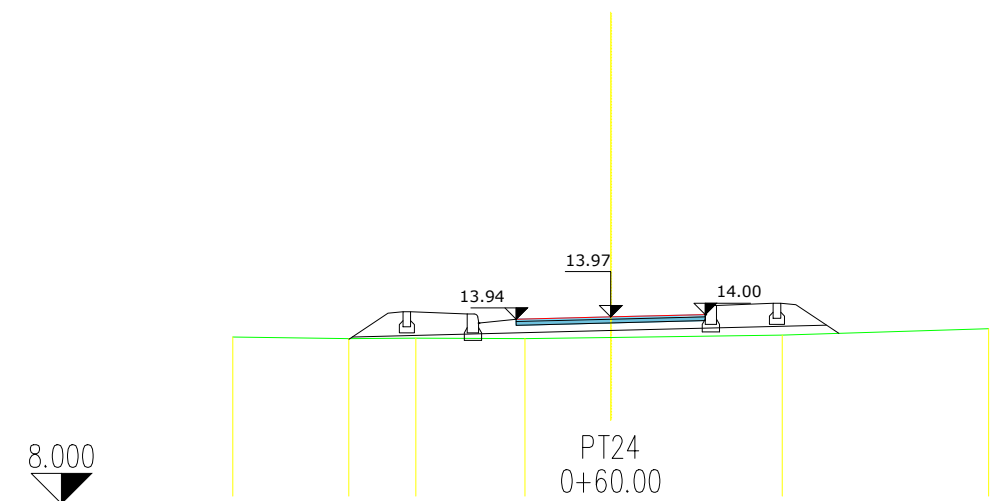

| | | | | | |
|-----------|--------|--------|--------|--------|--------|
| ROADWAY | | 13.939 | 13.970 | 14.001 | |
| FROM.AXIS | | 1.250 | 0.000 | 1.250 | |
| TERRAIN | 13.603 | 13.583 | 13.588 | 13.582 | 13.598 |
| FROM.AXIS | 5.000 | 3.464 | 2.577 | 1.134 | 0.000 |

Porositi:



Bashkia Shkoder

Projektoi:

"LENI-ING" sh.p.k

Administrator Ing. Nikoll Paluca

Adresa: Tirane

Mobile: 068 20 42 270

Email: leni.ing@hotmail.com

Objekti: Sistemim - asfaltim i rrugës Oblike Qendër - Lagjja Lami dhe Rrashkej

Faza: **Projekt - Zbatimi**

Emërtimi i Fletës:

**PROFILAT
TERTHORE AKSI 3**

Shkalla:

Sh-1:100

Tiranë 2021

PT - 07

PROFILAT TERHORE

AKSI 3

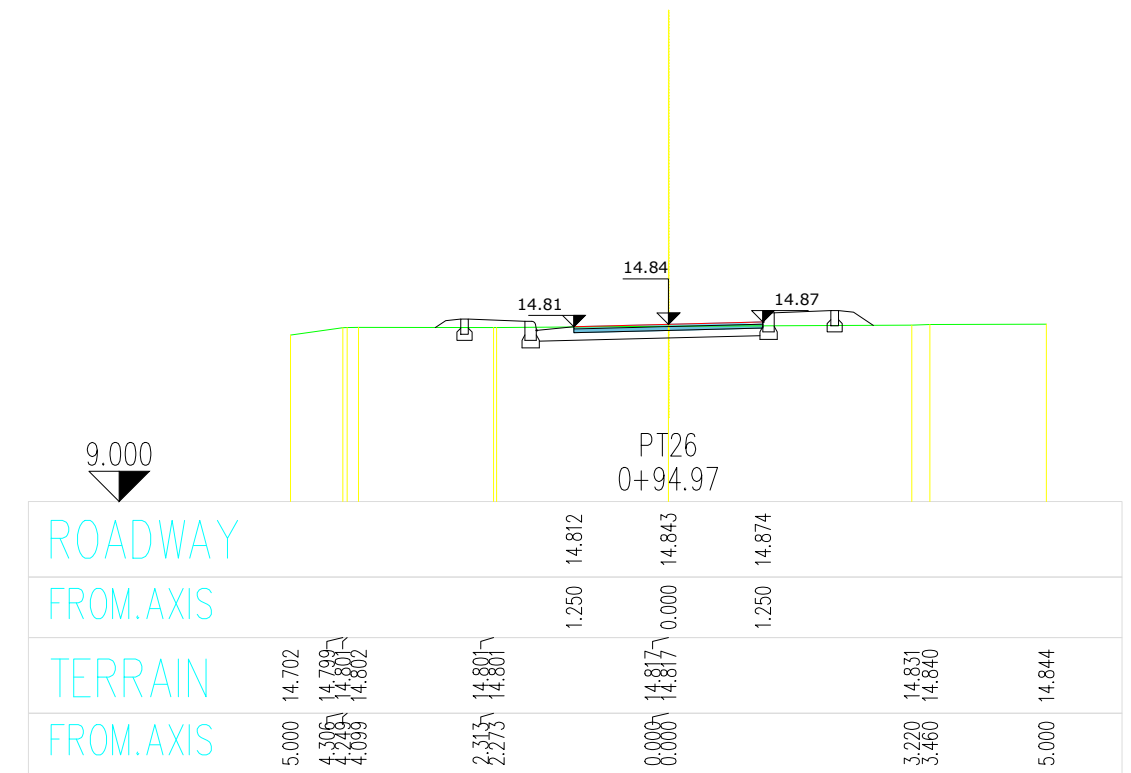
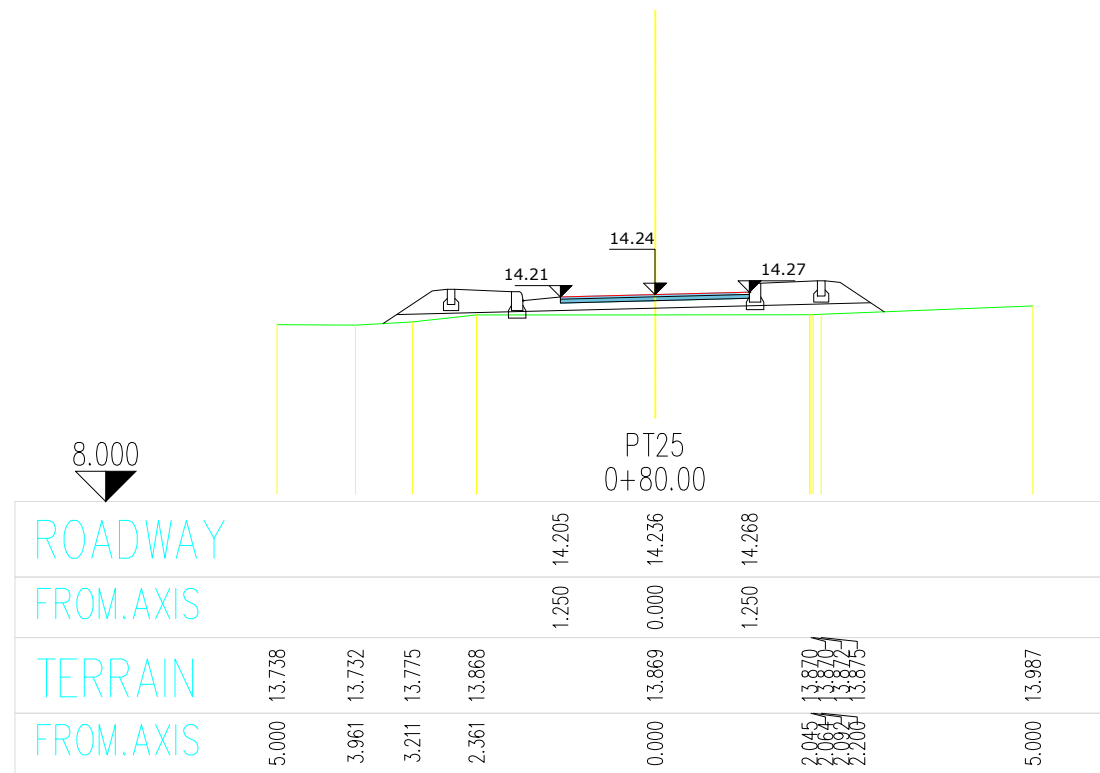

Porositi:



Bashkia Shkoder

Projektoi:

"LENI-ING" sh.p.k

Administrator Ing.Nikoll Paluca

Adresa: Tirane

Mobile: 068 20 42 270

Email: leni.ing@hotmail.com

Objekti: Sistemim - asfaltim i rrugës Oblike Qendër - Lagjja Lami dhe Rrashkej

Faza: **Projekt - Zbatimi**

Emërtimi i Fletës:

**PROFILAT
TERTHORE AKSI 3**

Shkalla:

Sh-1:100

Tiranë 2021

PT - 08

PROFILI TERTHORE TIP PER AKSIN 1

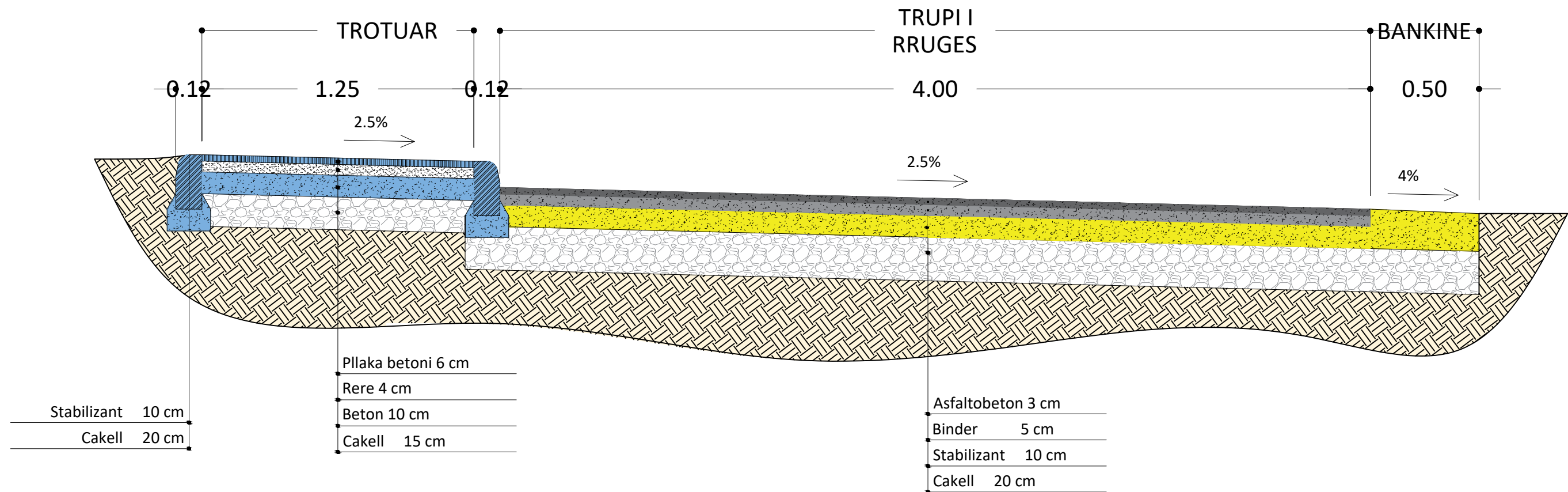

Porositi:



Bashkia Shkoder

Projektoi:

"LENI-ING" sh.p.k

Administrator Ing. Nikoll Paluca

Adresa: Tirane
 Mobile: 068 20 42 270
 Email: leni.ing@hotmail.com

| | | |
|--|-----------|-------------|
| Objekti: Sistemim - Asfaltim i rrugës Oblike Pallate | | |
| Faza: Projekt - Zbatimi | | |
| Emërtimi i Fletës: | Shkalla: | Tiranë 2021 |
| PROFILI TERTHORE TIP | Sh - 1:20 | Tp - 01 |

PROFILI TERTHORE TIP PER AKSET 2,3

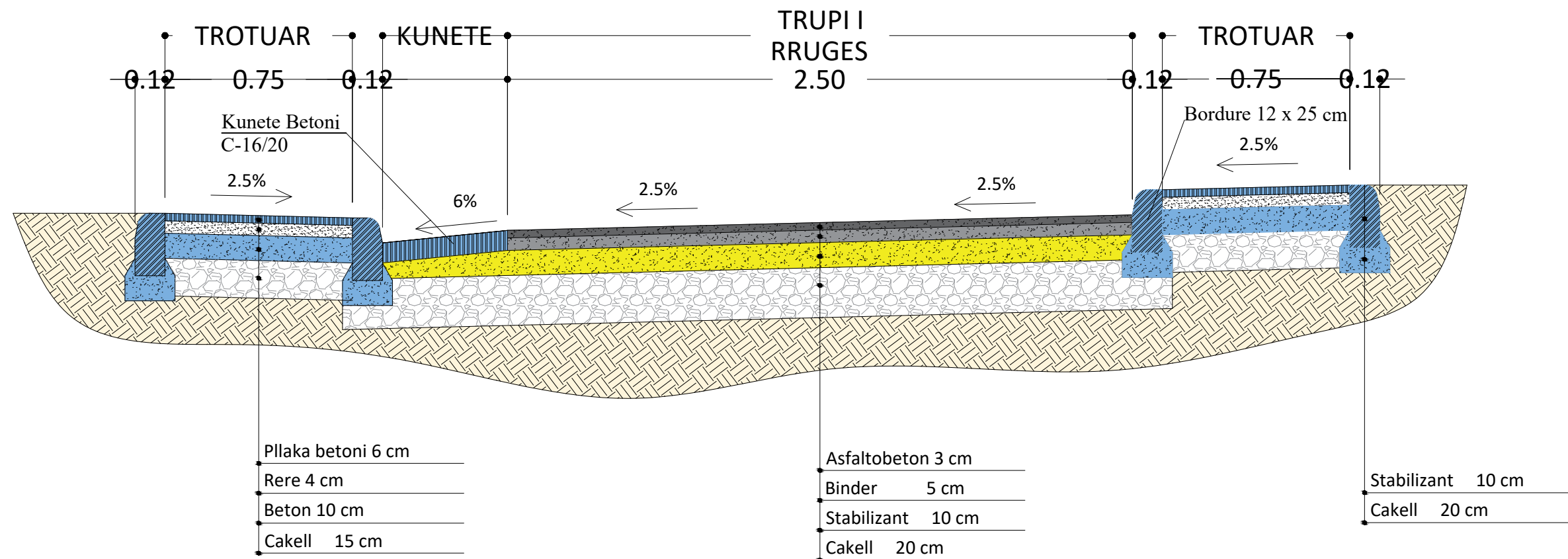

Porositi:



Bashkia Shkoder

Projektoi:

"LENI-ING" sh.p.k

Administrator Ing.Nikoll Paluca

Adresa: Tirane

Mobile: 068 20 42 270

Email: leni.ing@hotmail.com

Objekti: Sistemim - Asfaltim i rrugës Oblike Pallate

Faza:

Projekt - Zbatimi

Emërtimi i Fletës:

PROFILI TERTHORE
TIP

Shkalla:

Sh - 1:20

Tiranë 2021

Tp - 02

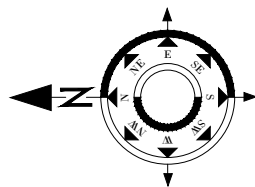
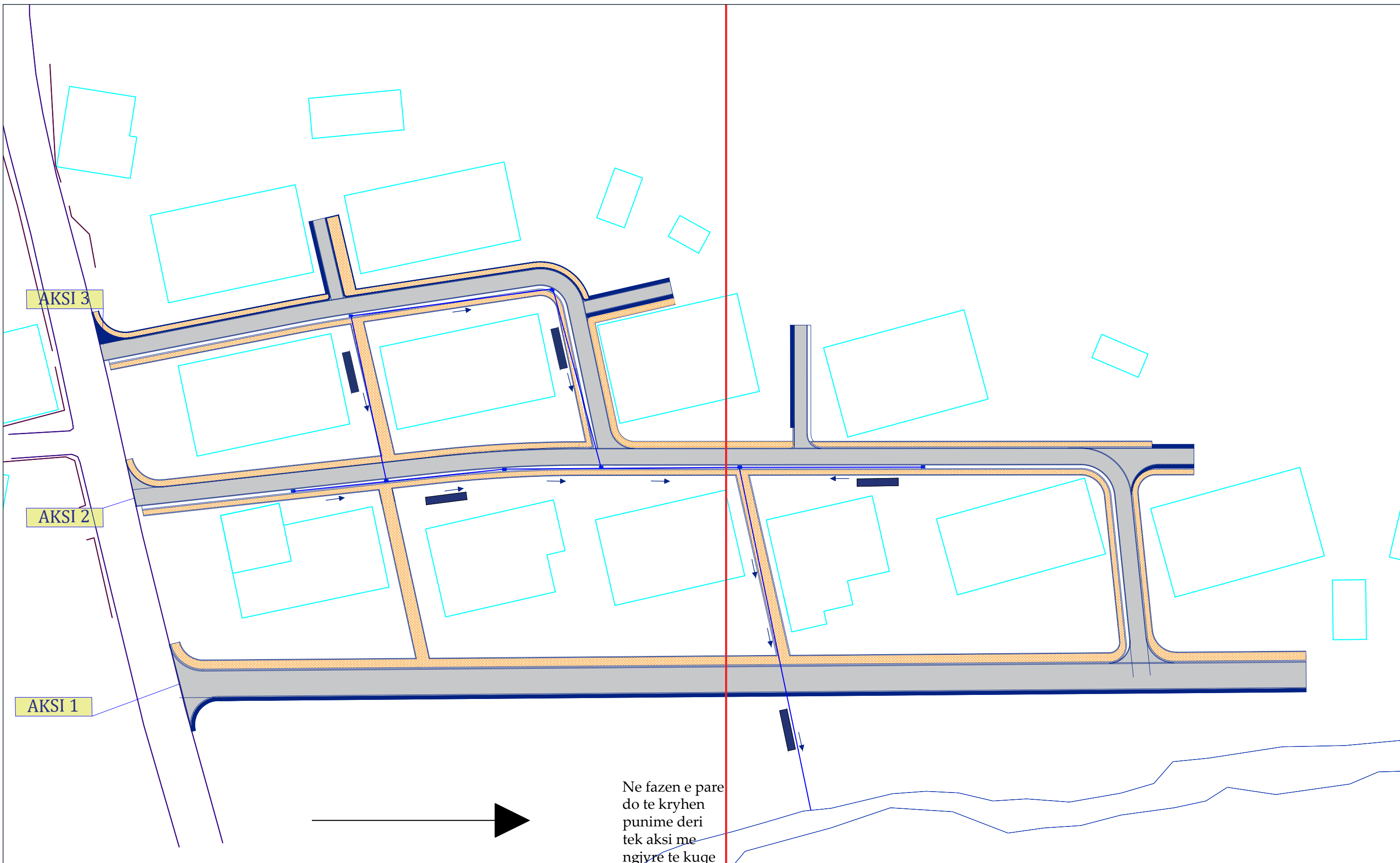

Porositi:

Bashkia Shkoder

Projektoi:

"LENI-ING" sh.p.k

Administrator Ing.Nikoll Paluca

Adresa: Tirane
 Mobile: 068 20 42 270
 Email: leni.ing@hotmail.com

| | | |
|--|----------|--------------------------|
| Objekti: Sistemim - Asfaltim i rrugës Oblike - Pallate | | |
| Faza: | | Projekt - Zbatimi |
| Emërtimi i Fletës: | Shkalla: | Tiranë 2021 |
| PLANIMETRIA KUB | Sh-1:500 | T-01 |

PROFILI GJATESORE KUB

PROFILI GJATESOR
aksi 1 kub
SH_H - 1:1000
SH_V - 1:100

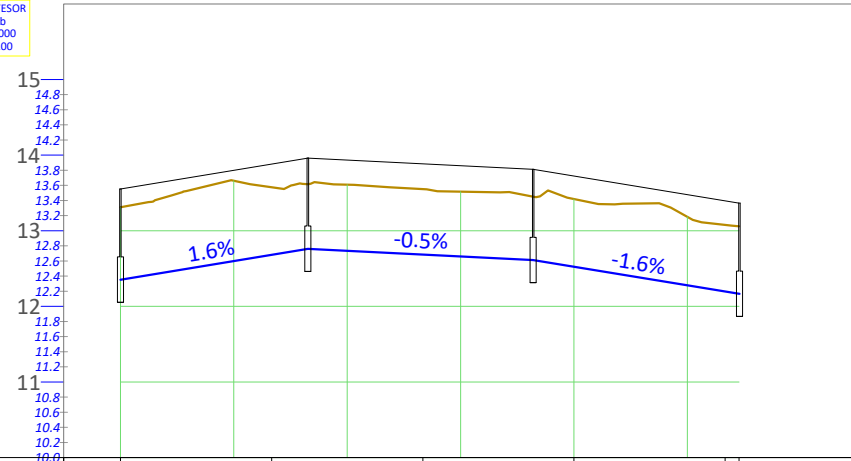

| NR I PRERJES | CS - 1 | CS - 2 | CS - 3 | CS - 4 | CS - 5 | CS - 6 |
|-------------------|--------|-------------------------|--------------------------|--------------------------|--------|--------|
| DIST. PJESORE | | 20.0 m | 20.0 m | 20.0 m | 20.0 m | 1.8 m |
| DIST. PROGRESIVE | 0+000 | 0+020 | 0+040 | 0+060 | 0+080 | 0+082 |
| KUOTA TOKES | 13.31 | 13.58 | 13.55 | 13.42 | 13.08 | 13.06 |
| KUOTA PROJEKTIT | 12.35 | 12.68 | 12.68 | 12.52 | 12.20 | 12.17 |
| KUOTA PUNES | -0.96 | -0.89 | -0.87 | -0.90 | -0.88 | -0.89 |
| GJEO. VERTIKALE | | $L=24.79$ $i=1.65\%$ | $L=29.81$ $i=-0.50\%$ | $L=27.29$ $i=-1.64\%$ | | |
| GJEO. HORIZONTALE | | L=24.79 | L=29.81 | L=27.23 | | |
| KILOMETRAZHI | 0.01 | 0.02 | 0.03 | 0.04 | 0.06 | 0.08 |

PROFILI GJATESOR
aksi 2 kub
SH_H - 1:1000
SH_V - 1:100

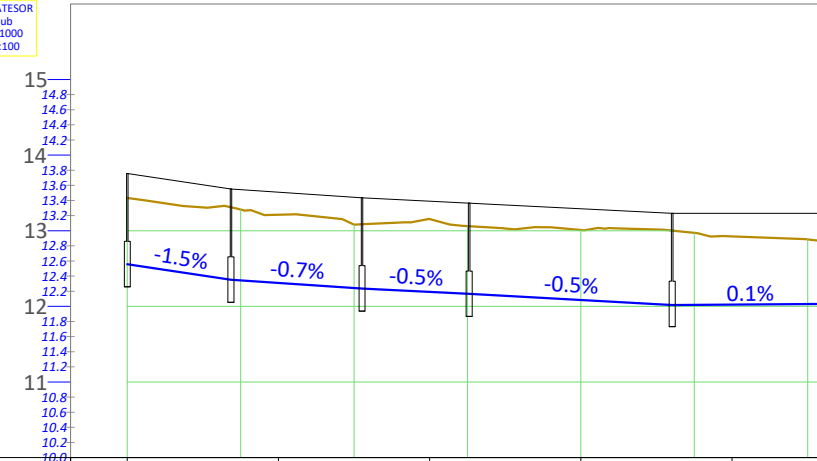

| NR I PRERJES | CS - 1 | CS - 2 | CS - 3 | CS - 4 | CS - 5 | CS - 6 |
|-------------------|--------|--------------------------|--------------------------|--------------------------|--------------------------|-------------------------|
| DIST. PJESORE | | 20.0 m | 20.0 m | 20.0 m | 20.0 m | 12.3 m |
| DIST. PROGRESIVE | 0+000 | 0+020 | 0+040 | 0+060 | 0+080 | 0+092 |
| KUOTA TOKES | 13.43 | 13.21 | 13.15 | 13.01 | 12.93 | 12.86 |
| KUOTA PROJEKTIT | 12.56 | 12.31 | 12.19 | 12.09 | 11.99 | 11.93 |
| KUOTA PUNES | -0.88 | -0.90 | -0.96 | -0.92 | -0.93 | -0.93 |
| GJEO. VERTIKALE | | $L=13.78$ $i=-1.50\%$ | $L=17.34$ $i=-0.67\%$ | $L=14.18$ $i=-0.50\%$ | $L=26.85$ $i=-0.50\%$ | $L=20.33$ $i=0.01\%$ |
| GJEO. HORIZONTALE | | L=31.05 | L=34.36 | L=26.85 | | |
| KILOMETRAZHI | 0.01 | 0.03 | 0.06 | 0.09 | 0.11 | |

PROFILI GJATESOR
aksi 3 kub
SH_H - 1:1000
SH_V - 1:100

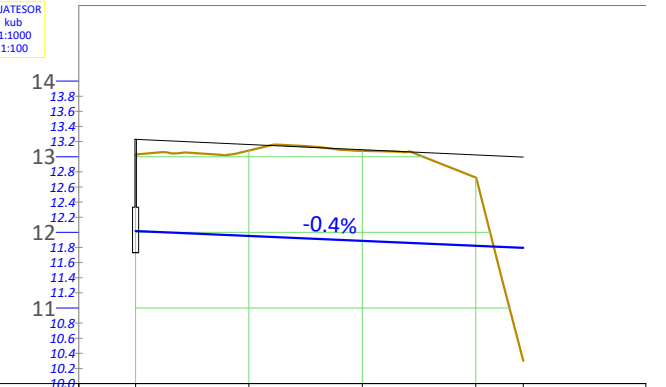

| NR I PRERJES | CS - 1 | CS - 2 | CS - 3 | CS - 4 | CS - 5 |
|-------------------|--------|--------------------------|--------|--------|--------|
| DIST. PJESORE | | 15.0 m | 15.0 m | 15.0 m | 6.3 m |
| DIST. PROGRESIVE | 0+000 | 0+015 | 0+030 | 0+045 | 0+051 |
| KUOTA TOKES | 13.03 | 13.08 | 13.08 | 12.72 | 10.30 |
| KUOTA PROJEKTIT | 12.03 | 11.96 | 11.89 | 11.82 | 11.80 |
| KUOTA PUNES | -1.00 | -1.12 | -1.18 | -0.90 | 1.50 |
| GJEO. VERTIKALE | | $L=51.28$ $i=-0.46\%$ | | | |
| GJEO. HORIZONTALE | | L=51.28 | | | |
| KILOMETRAZHI | 0.01 | 0.02 | 0.03 | 0.04 | 0.06 |

Porositi:



Bashkia Shkoder

Projektoi:

"LENI-ING" sh.p.k

Administrator Ing. Nikoll Paluca

Adresa: Tirane

Mobile: 068 20 42 270

Email: leni.ing@hotmail.com

Objekti: Sistemim - Asfaltim i rrugës Oblike - Pallate

Faza:

Projekt - Zbatimi

Emërtimi i Fletës:
PROFILI
GJATESORE
KUB

Shkalla:
Sh-1:500

Tiranë 2021

T-01